

# Connected Systems

e-CATALOG  
1.1\_2024

E N G L I S H

**ISEO**<sup>®</sup>  
ULTIMATE ACCESS TECHNOLOGIES



# Connected Systems

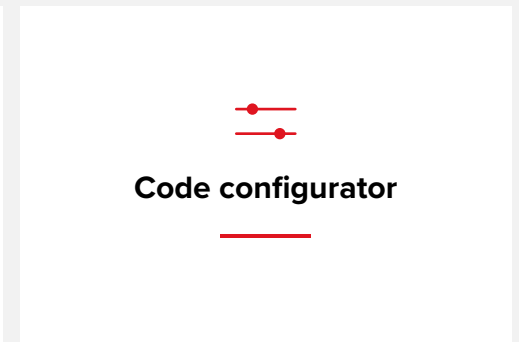
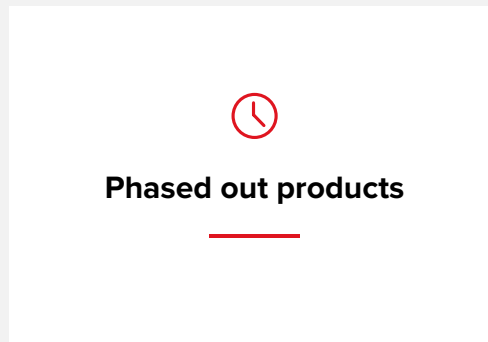
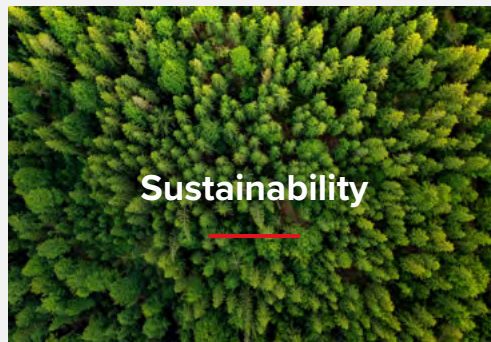
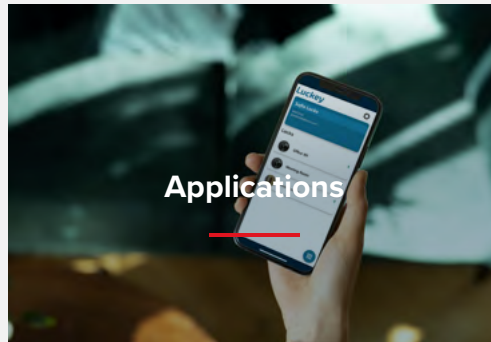
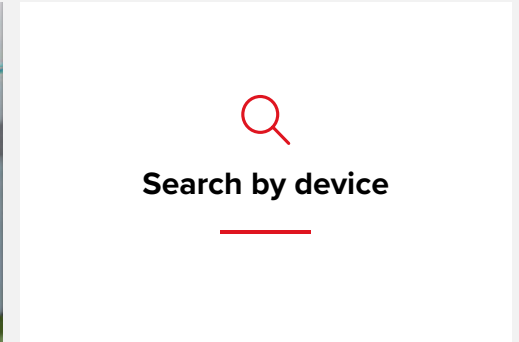

New

## 1NCA

The ultimate solution for state-of-the-art security.

With weather resistance and a robust design, the new reader ensures safe and reliable access to any external environment. Advanced features and simple installation make the new reader of the 1NCA range the perfect choice for reliable and long-lasting access control. **Learn more and protect your spaces today.**

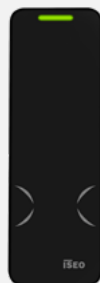

## MA1A

The new electronic handle. A Made in Italy excellence that combines design and functionality.

Compact and easy to use, this battery-powered handle fits perfectly on any type of door. Enjoy the convenience of keyless access and the security of a reliable system.



Discover MA1A  
 Simple. Practice. Safe.



# ISEO Solutions



## Success stories

Discover some of the most beautiful stories created with ISEO applications



# Applications

## V364

---

Simple and flexible management of spaces.

ISEO V364 is a user-friendly web-based access control system for commercial applications that allows the management of doors both online and offline for structures of various sizes.



## LSA

---

The application suitable for creating customized solutions for various fields.

Locken Smart Access (LSA) is a web-based, customizable, and multi-user software used by administrators and access managers in Utilities and Telco to configure and operate the ISEO access control system.



## Luckey

---

Much more than access control in buildings.

Luckey is Sofia part of ISEO PropTech access control system. A cutting-edge technological solution that revolutionizes the management of spaces and resources in buildings.



## Applications

# V364 / On-demand access OnTime Online

ISEO V364 is a user-friendly web-based access control system for commercial applications that allows the management of doors both online and offline for structures of various sizes. V364 gives you the freedom to access, manage, and control entry points of your facility from anywhere via a browser and on the go.

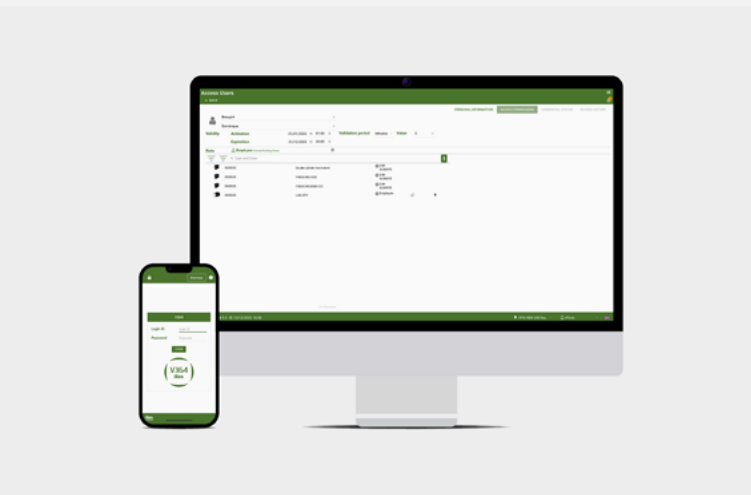

### Web based

The core of the system ISEO V364 is the Atlas Master embedding a web server which provides a fully functional access control server solution in a fraction of the time of conventional software. With no software to install, setup is quick and simple. Just connect the system components and then open a web browser to launch the intuitive interface which guides you through the process of configuring and managing your system.

### User friendly

ISEO V364 Access Management System provides ease of use and time saving for the administrators wherever high security standards apply and prompt access rights need to be issued for employees and mobile workforce and gives you the freedom to access, manage and control your facility's points of entry from anywhere with a browser and in mobility.

Go to page

### V364 APPLICATIONS

- On Air (SaaS) p. 8
- Customer Hosted p. 9
- Classic p. 10

## Applications

# V364 On Air (SaaS)



The Virtual Atlas Master is hosted in the ISEO data center, easily accessible via the Internet at any time and from anywhere. With this solution, customers do not need to have a physical Atlas Master device.

SaaS (Software as a Service) with a recurring monthly fee including the license, IT support and hosting (according to the ISO 27001 information security standard)

## Licenses

UNITS	System with RFID devices	System with RFID devices and F9000 keys
Until 100	0041800	0041810
Until 300	0041801	0041811
Until 500	0041802	0041812
Until 1000	0041803	0041813
Until 2000	0041804	0041814
Until 5000	0041805	0041815
Until 15000	0041806	0041816

## Technical features

### MAIN FUNCTIONS

- RFID/Bluetooth device management
- Management of F9000 keys, cylinders and padlocks
- Mobile Key\*
- Mobile validation of F9000 ON keys
- Customer UID management in Mifare Classic\*
- Role-based access control
- System partitions\*

### CREDENTIALS

- Badges
- Keyfob
- Bracelet
- Smartphones
- Mechatronic key

### COMPATIBILITY

ISEO 1RIS Platform

### LICENSE

The monthly fee is invoiced in January (or month of installation) for the entire remaining year.

### SOFTWARE INSTALLATION

The software is pre-installed in the Virtual Atlas Master hosted in ISEO Datacenter.

### SOFTWARE SUPPORT AND MAINTENANCE

The monthly fee includes maintenance and remote software support.

### SYSTEM INTEGRATIONS

APIs available

### APP DOWNLOAD

ISEO V364



ISEO Mobile Key



\*Configured upon request

## ONLINE CONTENT



Web page



System brochure



Administrator manual



V364 Security by design

## SERVICES



Commissioning



Training



Customizations



Technical support



Project Management





## Applications

# V364 Customer Hosted

Virtual Atlas Master can be installed in customer's own data centers on Linux virtual machines. Customer is responsible of setting up, installing and maintaining the environment for V364, taking regular backups of databases and other maintenance tasks such as updates to new software version.

## Licenses

UNITS	System with RFID devices and F9000 keys	Remote assistance service
Until 500	0041822	0041832
Until 1000	0041823	0041833
Until 2000	0041824	0041834
Until 5000	0041825	0041835
Until 15000	0041826	0041836

## Technical features

### MAIN FUNCTIONS

- RFID/Bluetooth device management
- Management of F9000 keys, cylinders and padlocks
- Mobile Key\*
- Mobile validation of F9000 ON keys
- Customer UID management in Mifare Classic\*
- Role-based access control
- System partitions\*

### CREDENTIALS

- Badges
- Keyfob
- Bracelet
- Smartphones
- Mechatronic key

### COMPATIBILITY

ISEO 1RIS Platform

### LICENSE

Virtual Atlas Master Customer Hosted with one-off V364 license lump sum

### SOFTWARE INSTALLATION

The license does not include any installation services. All services, from configuration to commissioning of the V364 system, are quoted separately.

### SOFTWARE SUPPORT AND MAINTENANCE

V364 Customer Hosted can only be provided together with a mandatory Maintenance Contract, allowing remote support connection. The Maintenance Contract is based on a monthly fee billed in January (or the installation month) for the entire remaining year. The monthly fee includes software maintenance and remote assistance.

### APP DOWNLOAD

ISEO V364



ISEO Mobile Key



\*Configured upon request

## ONLINE CONTENT



Web page



System brochure



Administrator manual



V364 Security by design

## SERVICES



Commissioning



Training



Customizations



Technical support



Project Management

## Applications

# V364 Classic



The Atlas Master is a Solid State Atlas Controller with Built-In Web Server Platform. There is no need to install any software or to buy a dedicated computer server: it's all in the Atlas Box which comes as solid state pre-configured appliance allowing, the system up and running in minutes.

## Licenses

UNITS	System with RFID devices	System with RFID devices and F9000 keys	Remote assistance service
Until 100	0041840	0041850	0041860
Until 300	0041841	0041851	0041861
Until 500	0041842	0041852	0041862
Until 1000	0041843	0041853	0041863

## Technical features

### MAIN FUNCTIONS

- RFID/Bluetooth device management
- Management of F9000 keys, cylinders and padlocks
- Role-based access control

### CREDENTIALS

- Badges
- Keyfob
- Bracelet
- Smartphones
- Mechatronic key

### COMPATIBILITY

ISEO 1RIS Platform

### LICENSE

This setup requires an Atlas Master as a device with pre-installed V364 software with a one-off V364 license.

### SOFTWARE INSTALLATION

Software pre-installed in the ATLAS appliance.

### SOFTWARE SUPPORT AND MAINTENANCE

V364 Classic license includes the first year of Remote Support and Software maintenance by signing the Maintenance Contract for a minimum of 3 years and allowing connection for remote support.

### APP DOWNLOAD

ISEO V364



## ONLINE CONTENT



Web page



System brochure



Administrator manual



V364 Security by design

## SERVICES



Commissioning



Training



Customizations



Technical support



Project Management

## Applications

# LSA / Web-based multi-user customizable software

Locken Smart Access (LSA) is a web-based multi-user customizable software that is used by administrators and access managers to configure and operate ISEO's access control system. This new-generation software is aimed at simplifying access management for all types of solutions, whether small, medium, large or complex systems.

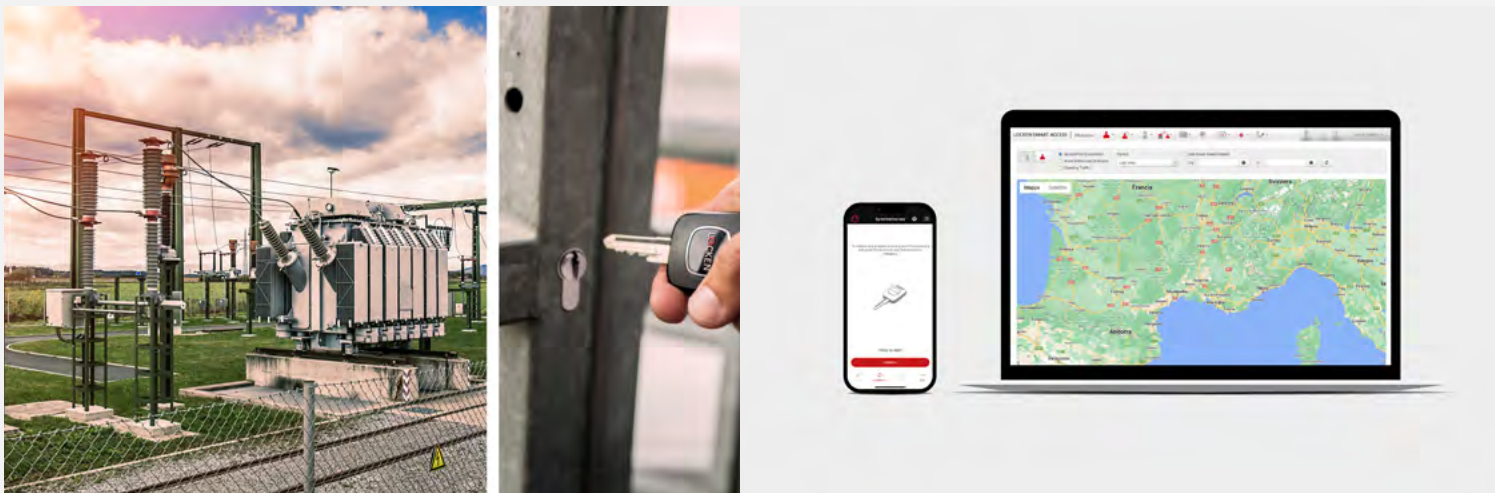

### Web based

LSA software is a web-based solution, accessible through an internet browser. This mode offers significant advantages. Flexible access allows users to connect from any online device, eliminating complex local installations. Streamlined updates ensure access to the latest versions effortlessly. Collaboration is simplified, enabling multiple users to work simultaneously, improving communication and data sharing. Data centralization ensures secure management, protecting against unauthorized access. Overall, the web-based software optimizes business processes with flexibility, straightforward updates, efficient collaboration, and enhanced data security.

### Customizable

Flexibility melds simplicity and responsiveness without compromising on security and reliability. ISEO's experts provide tailored assistance, guaranteeing that both LSA and the MyLocken application can be adjusted to align seamlessly with each company's unique branding, needs, and preferences. Furthermore, the MyLocken application goes beyond basic features, introducing a range of additional services. These services prioritize safety and security of the end users.

Go to page

### LSA APPLICATIONS

- LSA Welcome SaaS p. 12
- LSA Evo SaaS p. 13
- LSA Evo On Premise p. 14

## Applications

# LSA Welcome SaaS



LSA version dedicated to installations with simple access management rules, modified by the manager using a simple and intuitive Matrix tool. SaaS (Software as a Service) with a recurring annual subscription including the license, IT support and hosting (according to the ISO 27001 information security standard)

### Technical features

#### MAIN FUNCTIONS

- RFID/Bluetooth device management
- Management of F9000 keys, cylinders and padlocks
- Mobile Key
- Mobile validation of F9000 ON keys
- Customer UID management in Mifare Classic
- Role-based access control
- System partitions
- Matrix access configuration module
- Viewing access points on the map\*
- Viewing access points on the blueprint\*
- Dashboard\*
- Crisis mode\*

#### CREDENTIALS

- Badges
- Keyfob
- Bracelet
- Smartphones
- Mechatronic key

#### COMPATIBILITY

ISEO IRIS Platform

#### LICENSE

The yearly fee starts the month of the commissioning of the system.

#### SOFTWARE INSTALLATION

The software is pre-installed in the Virtual Atlas Master hosted in ISEO Datacenter.

#### SOFTWARE SUPPORT AND MAINTENANCE

The annual fee includes maintenance and remote software support.

#### APP DOWNLOAD

MyLocken



MyValidator



### Licenses

UNITS	LSA WELCOME SaaS
Until 100	0041700
Until 300	0041701
Until 500	0041702

\*Configured upon request

### SERVICES



Commissioning



Training



Customizations



Technical support



Project Management



## Applications

# LSA Evo SaaS



LSA Pro version designed for multi-site installations with complex access management rules and multi-site. SaaS (Software as a Service) with a recurring annual subscription including the license, IT support and hosting (according to the ISO 27001 information security standard)

## Licenses

UNITS	LSA EVO SaaS
Until 200	0041710
Until 500	0041711
Until 1000	0041712
Until 2000	0041713
Until 5000	0041714
Until 10000	0041715
Until 15000	0041716

## Technical features

### MAIN FUNCTIONS

- RFID/Bluetooth device management
- Management of F9000 keys, cylinders and padlocks
- Mobile Key
- Mobile validation of F9000 ON keys
- Customer UID management in Mifare Classic
- Role-based access control
- System partitions
- Matrix access configuration module\*
- Viewing access points on the map\*
- Viewing access points on the blueprint\*
- Dashboard\*
- Crisis mode\*

### CREDENTIALS

- Badges
- Keyfob
- Bracelet
- Smartphones
- Mechatronic key

### COMPATIBILITY

ISEO IRIS Platform

### LICENSE

The yearly fee starts the month of the commissioning of the system.

### SOFTWARE INSTALLATION

The software is pre-installed in the Virtual Atlas Master hosted in ISEO Datacenter.

### SOFTWARE SUPPORT AND MAINTENANCE

The annual fee includes maintenance and remote software support.

### APP DOWNLOAD

MyLocken



MyValidator



\*Configured upon request

## SERVICES



Commissioning



Training



Customizations



Technical support



Project Management



## Applications

# LSA Evo On Premise

On-premise LSA license installed with optional IT maintenance, support, and hosting.

## Licenses

UNITS	LSA EVO On Premise	Remote assistance service
Until 200	0041770	0041720
Until 500	0041771	0041721
Until 1000	0041772	0041722
Until 2000	0041773	0041723
Until 5000	0041774	0041724
Until 10000	0041775	0041725
Until 15000	0041776	0041726
Oltre 15000	0041778	0041728

## Technical features

### MAIN FUNCTIONS

- RFID/Bluetooth device management
- Management of F9000 keys, cylinders and padlocks
- Mobile Key
- Mobile validation of F9000 ON keys
- Customer UID management in Mifare Classic
- Role-based access control
- System partitions
- Matrix access configuration module\*
- Viewing access points on the map\*
- Viewing access points on the blueprint\*
- Dashboard\*
- Crisis mode\*

### CREDENTIALS

- Badges
- Keyfob
- Bracelet
- Smartphones
- Mechatronic key

### COMPATIBILITY

ISEO 1RIS Platform

### LICENSE

Virtual Atlas Master Customer Hosted with one-off LSA license lump sum.

### SOFTWARE INSTALLATION

The license does not include any installation services. All services, from configuration to commissioning of the LSA system, are quoted separately.

### SOFTWARE SUPPORT AND MAINTENANCE

LSA On Premise can only be provided together with a mandatory Maintenance Contract, allowing remote support connection. The Maintenance Contract is based on a yearly fee billed in January (or the installation month) for the entire remaining year. The yearly fee includes software maintenance and remote assistance.

### APP DOWNLOAD

MyLocken



MyValidator



\*Configured upon request

## SERVICES



Commissioning



Training



Customizations



Technical support



Project Management

## Applications

# Luckey / Cloud Native Access Control Solutions

With Luckey application, ISEO Ultimate Access Technologies and Sofia Locks provide an innovative solution designed for Flexible Workspaces (e.g. coworking), Flexible Living (e.g. co-living), and Flexible Retail (e.g. pop-up stores), enabling safe and flexible management, according to different needs, thanks to PropTech technology.

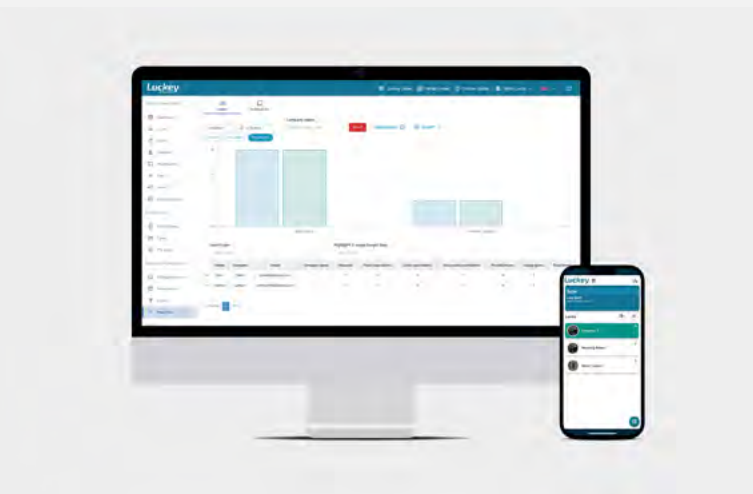

Go to page

### APPLICATIONS - Luckey

- [Luckey Basic SaaS](#) p. 16
- [Luckey Enterprise SaaS](#) p. 17

### Cloud Native

High level of redundancy and global presence guarantees continuous access and minimizes the impact of potential disruptions, providing users with a robust and reliable access control solution.

Systems are secure by design and GDPR compliant. Overall, emphasize best practices, encryption, authentication, and a “zero knowledge” secret management service to ensure robust security measures.

### Integrations

Luckey empowers you to extend the capabilities of your software and applications by integrating it with a complete access control system.

By integrating your software with Luckey, you can streamline operations, triggering events into and from the access control.

Additionally, integrating with Luckey allows you to ingest access control data into your management and analytics software, enabling comprehensive reporting, insights, and synchronized management.

### Plug-ins and Add-ons

The Cloud Native Access Control solution seamlessly integrates with a wide array of third-party software, thanks to partnerships with the best software providers in the market. Beyond core functionalities, the product offers a variety of add-ons to enhance platform capabilities. Manage resource bookings, calendars, and multi-site operations effortlessly, ensuring a cohesive and streamlined experience.

 [Visit the Luckey Store](#)

## Applications

# Luckey Basic SaaS



Luckey Basic is a Cloud Native Solution, offering competitive pricing model tailored to small and medium businesses. Thanks to its user-friendly interface and the simplicity of the architecture comprised of wireless "Data On Lock" devices, Luckey Basic is a system suitable for small to medium-sized projects.

## License

Description	Luckey Basic SaaS
Luckey credits pack - 300 credits	004S320
Luckey credits pack - 1 credit	004S321

## Technical features

### MAIN FUNCTIONS

- Luckey Basic manages systems up to 100 units (locks+users) Smartphone and RFID management
- 'Data on Lock' devices
- Simple and intuitive interface
- Single-site management
- Software features can be enhanced with the purchase of additional components on Luckey Store\*. Visit the Add-Ons section of Luckey Store. <https://luckeystore.sofialocks.com/category/add-ons/>

### CREDENTIALS

- Badges
- Keyfob
- Bracelet
- Smartphones

### COMPATIBILITY

ISEO ARGO Platform

### LICENSE

Luckey Credits will be used to pay for and activate subscriptions, as well as to purchase additional components and plug-ins. It is always possible to upgrade to Enterprise.

### SOFTWARE INSTALLATION

The software is pre-installed in the Virtual Atlas Master hosted in ISEO Datacenter.

### SOFTWARE SUPPORT AND MAINTENANCE

The annual fee includes maintenance and remote software support.

### SYSTEMS INTEGRATION

- Available APIs
- Software components developed by third-party technology partners and integrated are available on the Luckey Store. Visit the Plug-ins section of the Luckey Store. <https://luckeystore.sofialocks.com/category/plugin-ins/>

### APP DOWNLOAD

Luckey



\* In Luckey Basic, you can activate only the Bookey and Invitations add-ons.

## ONLINE CONTENT

- Web page
- Luckey help center

## SERVICES



Commissioning



Training



Customizations



Technical support



Project Management



## Applications

# Luckey Enterprise SaaS



Luckey Enterprise by Sofia part of ISEO is the professional application to manage not only mobile credentials, but also the use of space and resources: an advanced panel to manage security and create new business opportunities.  
Organizing and controlling the access of individual users and groups to rooms, buildings, or resources is very simple.

## Licenses

Description	Luckey Enterprise SaaS
Luckey credits pack - 300 credits	004S320
Luckey credits pack - 1 credit	004S321

## Technical features

### MAIN FUNCTIONS

- Unlimited number of users and smart locks
- Unlimited Smartphone and RFID Support
- Complete Analytics Dashboard
- Unlimited number of Plugins and Add-ons available
- Multi-site management and multi-tenant management
- Smart Groups Management
- Mechatronic Keys management
- Data on-card & Data on-lock

The functionality of the software can be enhanced with the purchase of additional components on the Luckey Store. Visit the Add-Ons section of the Luckey Store <https://luckystore.sofialocks.com/category/add-ons/>

### CREDENTIALS

- Badges
- Keyfob
- Bracelet
- Smartphones
- Mechatronic Key

### COMPATIBILITY

ISEO ARGO Platform  
ISEO 1RIS Platform

### LICENSE

Luckey Credits will be used to pay for and activate subscriptions, as well as to purchase additional components and plug-ins. It is always possible to upgrade to Enterprise.

### SOFTWARE INSTALLATION

The software is pre-installed in the Virtual Atlas Master hosted in ISEO Datacenter.

### SOFTWARE SUPPORT AND MAINTENANCE

The annual fee includes maintenance and remote software support.

### SYSTEMS INTEGRATION

- Available APIs
  - Available SDKs
- Software components developed by third-party technology partners and integrated are available on the Luckey Store. Visit the Plug-ins section of the Luckey Store. <https://luckystore.sofialocks.com/category/plugin-ins/>

### APP DOWNLOAD

Luckey



## ONLINE CONTENT

- Web page
- Luckey help center

## SERVICES



Commissioning



Training



Customizations



Technical support



Project Management

# 1RIS Integrated Resources of ISEO

1RIS is ISEO's comprehensive CONNECTED SYSTEMS platform designed for the future, that is modular and easy to integrate. It supports multiple mechanical, mechatronic, RFID, and mobile credentials, monitoring their life cycle. 1RIS is compatible with the ISEO software suite (V364, Luckey, and LSA) but is also open to integration with third-party software thanks to regularly updated SDKs.

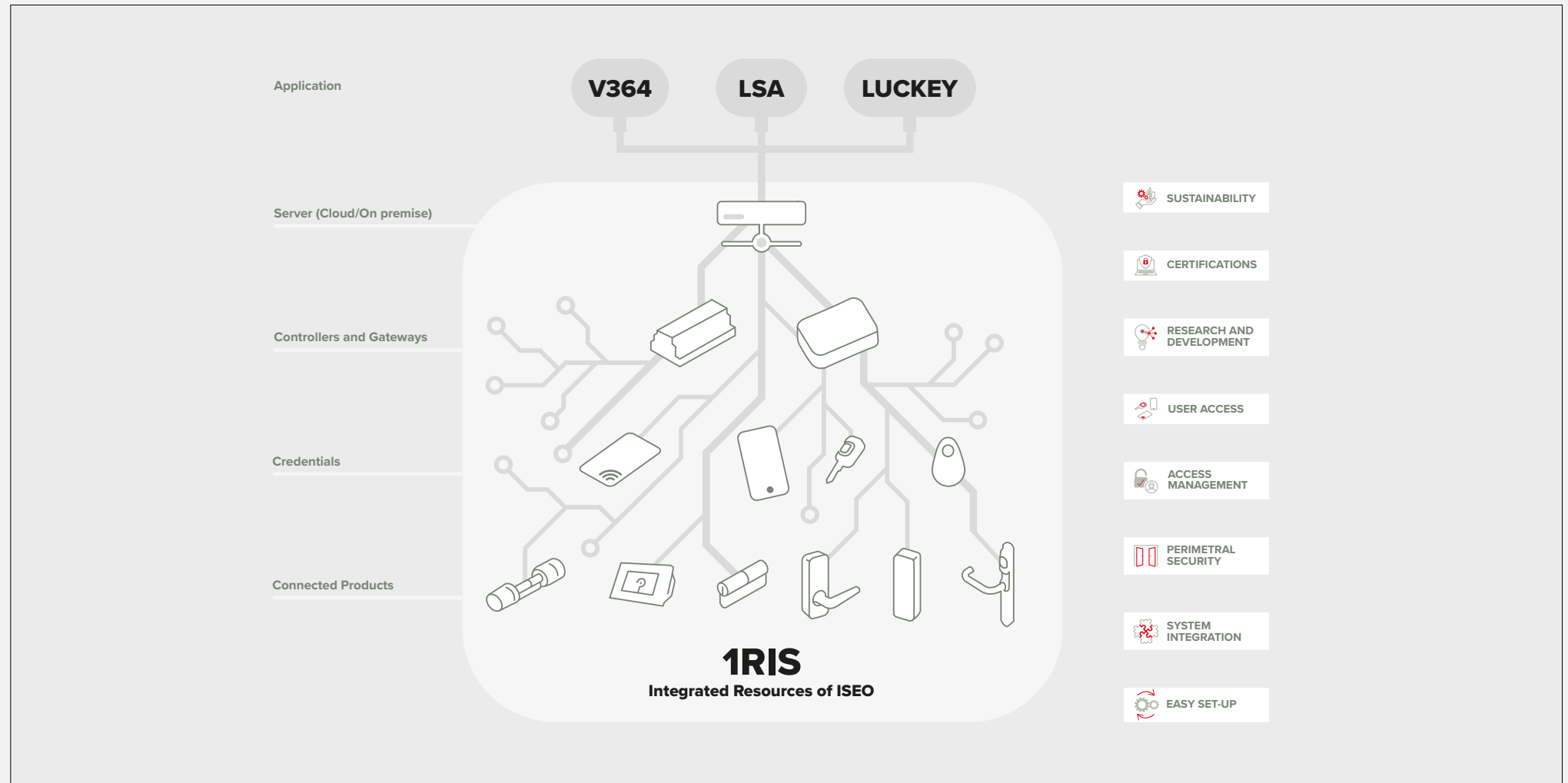

## Cybersecurity



The best solutions for the security of access control systems.

Cybersecurity in access control is crucial to ensuring the security of modern buildings. For ISEO, security is of vital importance, and to defend against security threats, it has implemented the following best practices from existing Internet security technologies in the field of cryptography:

- Symmetric and asymmetric encryption
- Transport Layer Security (TLS 1.3) security
- Digital certificates and Public Key Infrastructure (PKI)
- Authentication: the process by which each party verifies mutual identity and confirms communication with a trusted partner.



## Sustainability



At ISEO Sustainability is a priority.

With a constant evolution towards a sustainable future, ISEO has introduced the 1RIS product platform, a cutting-edge access control system that combines efficiency and environmental responsibility. Through the implementation of advanced energy solutions and the use of recyclable materials, ISEO stands out for its tangible commitment to reducing environmental impact.

The two key elements of the sustainability of ISEO solutions are their wireless installation and, in mechatronic key solutions, the use of battery-free cylinders. This innovative solution not only simplifies installation but also eliminates the need to use materials that are not easily recyclable, such as cables and batteries. Wireless technology not only provides greater flexibility in installation but also helps minimize resource consumption, promoting a more efficient and sustainable approach.

In summary, the 1RIS platform represents a cutting-edge option for access security, with a strong commitment to environmental sustainability. ISEO thus demonstrates its leadership in the industry not only for the efficiency of the access control system but also for environmental awareness, contributing to shaping a more sustainable future through innovative and responsible solutions



# Reading Guide

Home Button and Previous View

Device name

Device type

Device code

If there is the

Code configurator

click to create the code using the configurator of the specific device

Quick navigation to devices' main pages

Links to accessories pages

Links to online materials on [iseo.com](http://iseo.com)

Technical Data of the device

## Search by device

p. 23

Search by device

## **RFID and Bluetooth® access control devices**

# MA1A



## The smart handle for many applications

MA1A is the new electronic lock from the Connected range by ISEO, designed to easily manage access in businesses, commercial activities, co-working spaces, hotel environments, and utilities. With its compact and elegant design, MA1A is a Made in Italy excellence and represents the ideal retrofit solution for internal doors.

## Make your doors connected

MA1A can be opened through Argo the smartphone app conceived for iOS and Android device, with which the user can manage, monitor and open all the doors MA1A has been installed - RFID cards, tags, key fob. The installation of the smart handle is quick and effortless. It is easy to use and compatible with all DIN mechanical locks.

## Product features

- Wake up by RFID card detection or phone (patented)
- Low energy consumption device
- Real Time Clock/Calendar
- Light and acoustic signals
- Permanently open mode (office mode) without extra battery consumption
- Battery-operated device with charge status detection
- Anti passback function
- Software upgradeable on-site via Bluetooth® phone (Stand Alone)
- Four-eye principle (two valid credentials must be presented in sequence to open the lock)

### FINISH

 Technopolymer

### COLOR

 Glossy black

### ENVIRONMENTAL FEATURES

- IP54
- Max. 95% without condensing

### ACCESS CREDENTIALS

- Badge
- Bracelet
- Keyfob
- Smartphone

### COMMUNICATION INTERFACE

- RFID ISO14443B/Mifare ISO14443A
- Bluetooth® Low Energy 5.1

### CERTIFICATIONS

- CE (Conformitee Europeenne)
- UKCA (UK Conformity Assessed)
- EN16867:2020 with classification |3|7|0|B|1|4|B|D\*|0|0|
- EN1634-1 fire resistance EI90

\* B with Mifare Classic cards,  
D with Mifare DESFire cards

Go to page

## MODELS

→ Standard

p. 26

# MA1A

## Selection guide

The MA1A electronic handle is available with different handle sets.

The items required to adapt the different door types and to ensure correct installation are various and must be chosen from the options available according to the characteristics and the dimensions of the door and the specific usage requirements.

To ensure the correctness and completeness of the order, here is a guide for the selection of the various articles that make up the set for each door.

### ORDER THE PRODUCT IN A FEW STEPS

**1**

**Check the type of door** on which the MA1A Connected Smart Handle will be mounted.

**3**

**Compose the necessary spindle and screws kit.**

**2**

**Choose the handle set** you prefer.

**4**

**Optional.**  
Choose **lock to match**.

Go to page

Go to page

Go to page

Go to page

● **SELECTION GUIDE**

**MODELS**

→ Standard

p. 26

## MA1A Standard

### CONNECTED SMART HANDLE WITH RFID TECHNOLOGY AND Bluetooth®

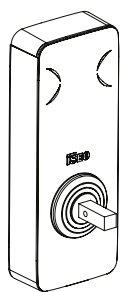

### Technical features

#### FIRMWARE

1RIS

#### POWER UNIT

3 alkaline batteries 1.5V type AAA

#### ESTIMATED BATTERY LIFE

Up to 2 years, up to 20.000 opening.  
The figure is dependent on the mode and environment of use and the options activated.

#### ALERTS

- Led 3-colour series green, red, blue
- Multi-frequency buzzer

#### PRODUCT COMPATIBILITY

- Backset min 35 mm (E)
- Escutcheon max diameter = 52mm (C)
- Min center-holes distance = 70mm (D)
- DIN holes = 38mm (DIN)
- Multiblindo Easy Exit Lateral compatible version (M)
- Max handle rotation angle 40°
- 7, 8 or 9 mm square spindle (\*)
- Recommended locks with latchbolt only or automatic deadbolt function
- Max door mass and dimensions 250 Kg, 1320 x 2520 mm (W x H)
- Door thickness 40 - 125 mm
- Compatible to all European DIN locks

(\*) 8mm square spindle required with MA1A handles provided by ISEO. 7 and 9mm square spindle compatible to MA1A available (go to Aries screws and handle follower kit).

#### MOUNTING

- On door

#### ENVIRONMENTAL FEATURES

- IP54
- Max. 95% without condensing

#### WORKING TEMPERATURE

-20°C ÷ +60°C

#### STORAGE TEMPERATURE

-20°C ÷ +70°C

#### PACKAGE

MA1A smart handle, 3x AAA 1,5Vdc alkaline batteries, torx key T8, anti-tilt kit.

#### ACCESSORIES (NOT INCLUDED)

- Handle Set (standard and with Safe-Touch antibacterial protection)
- Spindle and screws kit

cod. 00E40201525



#### DIMENSIONS

- Width: 56mm
- Length: 147mm
- Thickness: 24mm
- Handle length: 115 mm from the center of the plate

Weight  
600 g

#### ONLINE CONTENT

 Web page

 Data sheet

 Leaflet

 Installation guide

 Specifications

 Custom Handle Specifications

 Drilling Template



# MA1A

## Accessories

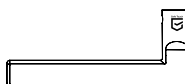
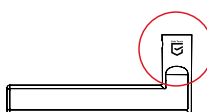
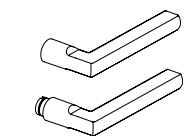
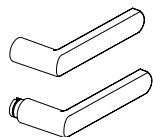

## HANDLE SET

### YUMA

#### MA1A Handle Set

Package: 1 MA1A external handle, 1 Internal handle, 1 Internal handle fixing plate with reinforcing spring and cover, 2 Internal and external cylinder escutcheons with covers.

Zamak Alloy – Matte Black RAL 9005

1 00.329.005

#### WITH SAFE TOUCH ANTIBACTERIAL PROTECTION

Safe Touch treatment applied to external and internal handle.

1 00.329.005A

Zamak Alloy – Satin Chrome

1 00.329.00Y

#### WITH SAFE TOUCH ANTIBACTERIAL PROTECTION

Safe Touch treatment applied to external and internal handles.

1 00.329.00YA

### URACAN

#### MA1A Handle Set

Package: 1 MA1A external handle, 1 Internal handle, 1 Internal handle fixing plate with reinforcing spring and cover, 2 Internal and external cylinder escutcheons with covers.

Stainless steel – Matte Black RAL 9005

1 00.431.005

#### WITH SAFE TOUCH ANTIBACTERIAL PROTECTION

Safe Touch treatment applied to external and internal handles.

1 00.431.005A

Satin Stainless steel

1 00.431.002

#### WITH SAFE TOUCH ANTIBACTERIAL PROTECTION

Safe Touch treatment applied to external and internal handles.

1 00.431.002A

# MA1A

## Accessories

### SPINDLE AND SCREWS KIT

Spindle and screws length related to door thickness (A)  
 Package includes: 1 square spindle, 2 M5 fixing screws with thread-locking.  
 NOTE: select the right kit depending on door thickness.

#### 8 mm square spindle \* and 2xM5 screws kit

Door thickness from 40 to 50 mm	1	201E004050A
Door thickness from 50 to 60 mm	1	201E005060A
Door thickness from 60 to 70 mm	1	201E006070A
Door thickness from 70 to 80 mm	1	201E007080A
Door thickness from 80 to max 125 mm (to be cut)	1	201E008010A

\* For 7 and 9mm square spindles, refer to Aries screws and handle follower kit chapter.

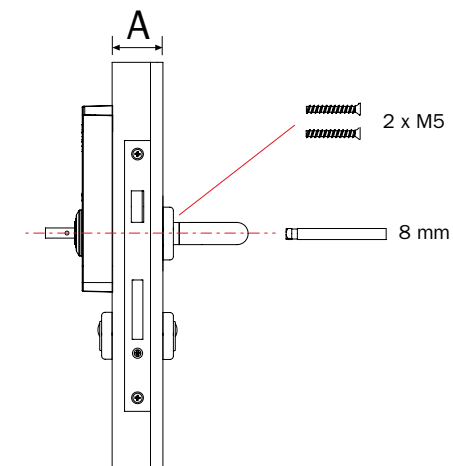

### LOCK (CAN BE COMBINED)

#### AUTOMATIC MECHANICAL LOCK

Mortise lock, automatic deadbolt function (18 mm extension)  
 Panic exit function, splitted latchbolt, equipped with devices against forced entry (reversible).  
 Backset: 55 mm, center distance: 85 mm, 8 mm handle follower  
 Chrome plated, squared/rounded frontplate.  
 Package: 1 lock, 1 striking plate.

Squared frontplate	1	207553.Z
Rounded frontplate	1	217553.Z

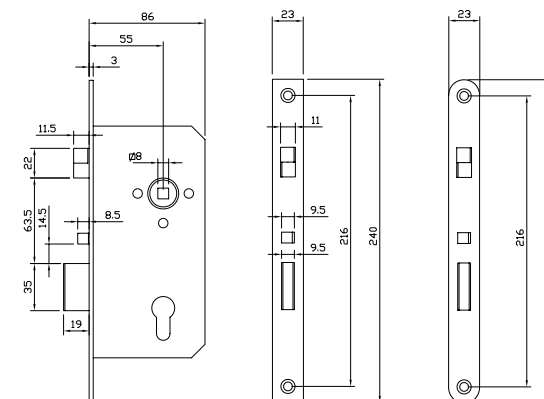

# 1NCA

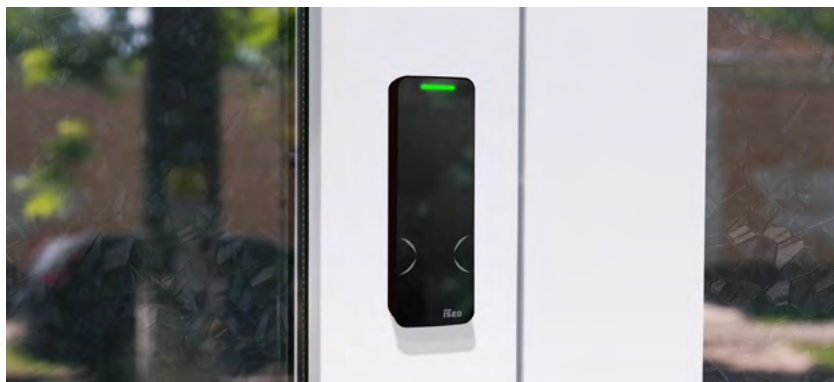



## A new range of multistandard readers

1NCA Readers is an innovative range of multi-standard, wall-mounted and weatherproof readers of ISEO Connected products line, designed for access management in residential and light commercial buildings. These readers can be easily installed and can manage internal doors but also outdoor gates since they have the IP66 certification.

## Elegant in every situation

All 1NCA readers combine sleek and minimalist design with premium and durable materials, which is well suited to different environments. Experience the perfect blend of elegance and reliability, elevating your security measures to new heights and unlocking your freedom to move

### FINISH

-  Technopolymer
-  Glass

### COLOR

-  Glossy black

## Product features

- Wake up by RFID card detection or phone (patented)
- Low energy consumption device
- Real Time Clock/Calendar
- Light and acoustic signals
- Permanently open mode (office mode) without no extra battery consumption
- Four-eye principle (two valid credentials must be presented in sequence to open the lock)
- Anti passback function
- Credential reader/validator when connected to the Atlas controller
- Software updatable on site via Bluetooth® phone (Stand Alone) or from Atlas controller (online)

### ENVIRONMENTAL FEATURES

- IP66
- Max. 95% without condensing

### ACCESS CREDENTIALS

- Badge
- Keyfob
- Bracelet
- Smartphone

### COMMUNICATION INTERFACE

- RFID ISO14443B/Mifare ISO14443A
- Bluetooth® Low Energy 5.1
- Lockbus

### CERTIFICATIONS

- Compliance to RED, European and UK directives concerning radio equipment regulations

Go to page

### MODELS

- Mullion Lockbus p. 31
- Mullion Relay p. 32

# 1NCA

## Selection guide

1NCA Smart readers are ISEO's new credential readers characterised by an elegant and contemporary design suitable for outdoor installation (IP66). They are available in various models to meet different installation and functional requirements.

### ORDER THE PRODUCT IN A FEW STEPS

#### 1

Choose the 1NCA Connected Reader model suitable for your application and click in the column on the right :

**Mullion Relay** Device with onboard relays for operating directly on electromechanical gates.

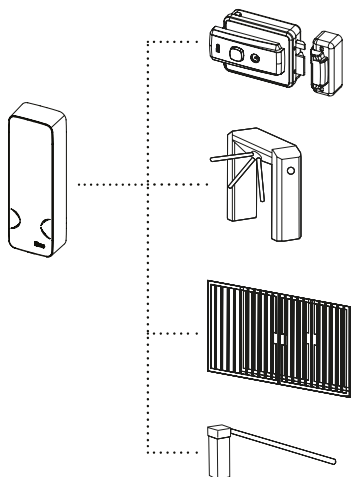

**Mullion Lockbus** Lockbus device for operating electromechanical gates in combination with the Actuator for electromechanical locks. Suitable for replacing the ISEO's Stylos reader.

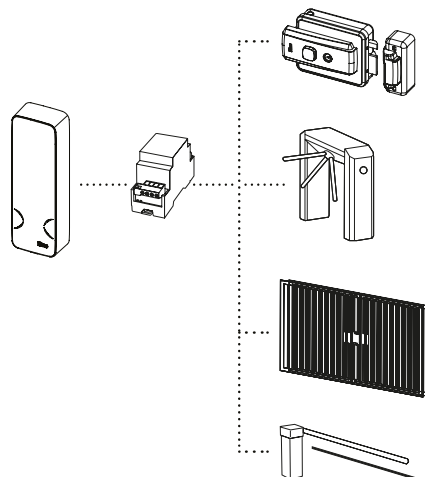

#### 2

**Optional.**  
Choose accessories to complete the system.

Go to page

#### ● SELECTION GUIDE

##### MODELS

→ Mullion Lockbus p. 31

→ Mullion Relay p. 32

## 1NCA Mullion Lockbus

### CREDENTIAL READER RFID TECHNOLOGY AND Bluetooth®, WITH LOCKBUS CONNECTION

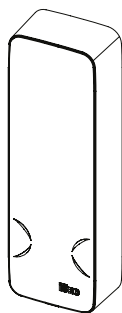

### Technical features

**FIRMWARE**  
1RIS

**POWER UNIT**  
9÷24 Vdc (1W)  
Automatic low power mode max 0,4mW  
Internal CR2032 3V Lithium battery for RTC (real time clock) backup

**ALERTS**  
- Led 3-colour series green, red, blue  
- Multi-frequency buzzer

**PRODUCT COMPATIBILITY**  
- Device with Lockbus interface. Suitable as a replacement of Stylos Smart, to couple with the electric lock actuator (5E2501)

**MOUNTING**  
- Wall mounted

**ENVIRONMENTAL FEATURES**  
- IP66  
- Max. 95% without condensing

**WORKING TEMPERATURE**  
-20°C ÷ +70°C

**STORAGE TEMPERATURE**  
-25°C ÷ +75°C

**PACKAGE**  
1 reader, 1 fixing bracket, Torx T8 key, 1 x Fixing bracket Torx screw (M2,5x5), instruction manual,  
2 x Screws (3,5x25 countersunk head) and wall plugs (5x25),  
Spacer with screws included (cod. 0000IS00354 )

**ACCESSORIES (NOT INCLUDED)**  
- Electric lock actuator (code 5E2501)

cod. 5E152312

 Accessories

#### DIMENSIONS

- Height: 146mm
- Width: 48mm
- Depth: 26mm

#### ONLINE CONTENT

-  Web page
-  Data sheet
-  Leaflet
-  Installation guide
-  Specifications

## 1NCA Mullion Relay

CREDENTIAL READER RFID CONTACTLESS  
MULTISTANDARD, Bluetooth®, WITH BUILT IN RELAY

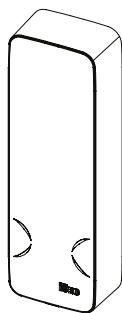

### Technical features

**FIRMWARE**  
1RIS

**POWER UNIT**  
9÷24 Vdc (1W)  
Automatic low power mode max 0,4mW  
Internal CR2032 3V Lithium battery for RTC (real time clock) backup

**ALERTS**  
- Led 3-colour series green, red, blue  
- Multi-frequency buzzer

**MOUNTING**  
- Wall mounted

**ENVIRONMENTAL FEATURES**  
- IP66  
- Max. 95% without condensing

**WORKING TEMPERATURE**  
-20°C ÷ +70°C

**STORAGE TEMPERATURE**  
-25°C ÷ +75°C

**PACKAGE**

1 reader, 1 fixing bracket, Torx T8 key, 1 x Fixing bracket Torx screw (M2,5x5), instruction manual, 2 x Screws (3,5x25 countersunk head) and wall plugs (5x25)

**ACCESSORIES (NOT INCLUDED)**

- Electric lock actuator (code 5E2501)
- Spacer with screws (code 0000IS00354)

cod. 5E152412



**DIMENSIONS**

- Height: 146mm
- Width: 48mm
- Depth: 26mm

ONLINE CONTENT

 Web page

 Data sheet

 Leaflet

 Installation guide

 Specifications



# 1NCA

## Accessories

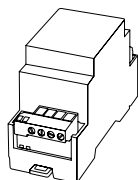

**Electric lock actuator**

1 relay + 1 booster.  
 3 inputs (1 digital, 1 analog, 1 digital/ analog)  
 Lockbus interface.  
 8-30Vdc Power Supply  
 DIN35 rail mounting.  
 Package: 1 actuator, instruction manual.

1 5E2501

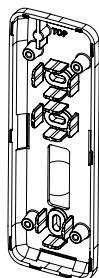

**Spacer with screws (for Mullion reader)**

2 x Screws (3,5x25 flat-head)  
 4 x Screws (3x8)

1 0000IS00354

# Aries 2.0



## Make your door Smart

The flexibility and simplicity of installation make Aries the ideal solution for access control of residential environments and public places (shopping centres, industries, public and private offices, schools and universities, hospitals and retirement homes, residences and hotels, etc.).

## For many applications

ARIES electronic trim set can be fit on most doors. It is conceived to be used also with the majority of mechanical locks, for the utmost installation flexibility. The battery operation and cableless technology makes ARIES the perfect solution for access management, ensuring utmost flexibility and low installation costs both on new and existing doors.

### FINISH

 Stainless

## Product features

- Handle movement detection.
- Emergency mechanical key detection.
- Privacy signal.
- Wake up by RFID card detection or phone (patented)
- Battery-operated device with charge status detection
- Low energy consumption device
- Real Time Clock/Calendar
- Anti passback function
- Light and acoustic signals
- Real Time Clock/Calendar
- Software upgradeable on-site via Bluetooth® phone (Stand Alone)
- Four-eye principle (two valid credentials must be presented in sequence to open the lock)

Go to page

### MODELS

- Standard p. 36
- For panic devices p. 37
- For custom handles p. 38
- For custom handles for panic devices p. 39
- For DIN lock p. 40
- For fire locks p. 41
- For Premi Apri Meroni locks p. 42

### ENVIRONMENTAL FEATURES

- IP55
- IP54

### ACCESS CREDENTIALS

- Badge
- Keyfob
- Bracelet
- Smartphone

### COMMUNICATION INTERFACE

- RFID ISO14443B/Mifare ISO14443A
- Bluetooth® Low Energy 5.1

### CERTIFICATIONS

- EN179 certification available in combination with specific locks
- EN1125 certification available in combination with specific panic devices and locks

# Aries 2.0

## Selection guide

The ARIES electronic handle is available in different versions to suit the costumers' needs and the characteristics of the doors on which it is to be installed. The articles required for correct installation are various and must be chosen from the options available both according to the characteristics and dimensions of the door and to the specific usage requirements.

To ensure the correctness and completeness of the order, here is a guide for choosing the various articles that make up the set for each door.

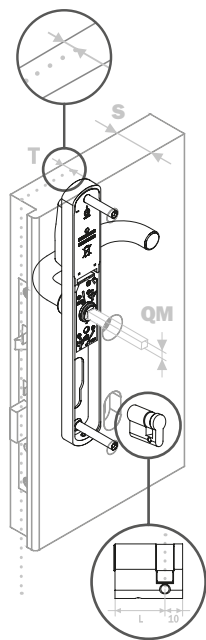

## ORDER THE PRODUCT IN A FEW STEPS

### 1

**Check the type and dimensions of the door**  
(in case of handle replacement on existing door)

### 3

**Compose the necessary spindle and screws kit** and check whether an **adapter plate kit is required** (for panic devices and DIN locks).

[Choose from menu](#)

[Spindle and screws kit](#)

[Adapter plate kit](#)

[Other accessories](#)

### 2

**Choose the Aries handle's model in the right column**, generating the code thanks to the configurator on the product page

### 4

**Optional.**  
Choose a **lock to match** from those available.

[Go to page](#)

Go to page

## ● SELECTION GUIDE

### MODELS

- Standard p. 36
- For panic devices p. 37
- For custom handles p. 38
- For custom handles for panic devices p. 39
- For DIN lock p. 40
- For fire locks p. 41
- For Premi Apri Meroni locks p. 42

## Aries 2.0 Standard

### ELECTRONIC TRIM SET STANDARD

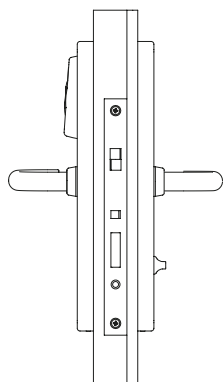

### Technical features

**FIRMWARE**  
1RIS

**RELEASE**  
2.0

**POWER UNIT**  
2 lithium batteries 3.6V type AA

**ESTIMATED BATTERY LIFE**  
Up to 2 years, up to 20.000 opening. The figure is dependent on the mode and environment of use and the options activated.

**ALERTS**  
- LEDs: 1 Green, 1 Red  
- Multi-frequency buzzer

**PRODUCT COMPATIBILITY**  
- Can be fit on any door (wooden, aluminium, metal, PVC and so on).  
- Door thickness 40 - 85 mm (with standard accessories), 85 - 120 mm (with special accessories).  
- Suitable for use fire/smoke resisting door assemblies.  
- 7, 8 or 9 (\*) mm handle follower. Center distance follower/cylinder 70, 72, 85, 88 and 92 mm.  
- Backset: 25mm minimum, if using nylon underplate to cover holes on door backset minimum 40mm. European profile cylinder hole.  
- Latchbolt only or automatic deadbolt function.  
- Max handle rotation angle 40°.

(\*) with adaptor

**MOUNTING**  
- On door

**ENVIRONMENTAL FEATURES**  
- IP55  
- IP54

**WORKING TEMPERATURE**  
-20°C ÷ +60°C

**STORAGE TEMPERATURE**  
-25°C ÷ +75°C

**PACKAGE**  
1 trim (pair), 2 batteries, 2 mm hex key, instruction manual.  
NOTE: Handle follower and fixing screws set, mechanical override cylinder and mechanical lock not included.

**ACCESSORIES (NOT INCLUDED)**  
- Handle follower and screws set (mandatory)  
- Override cylinder  
- Override keys set  
- Underplate  
- Lock

 Code configurator

 Accessories

#### DIMENSIONS

- Plate width: 38 mm;
- Plate length: 294 mm;
- Plate thickness: 17 mm;
- Handle length: 131 mm from plate center;

Weight  
1530 g

#### ONLINE CONTENT

 Web page

 Installation guide

 Data sheet

 Specifications

 Leaflet

## Aries 2.0 For panic devices

### ELECTRONIC TRIM SET FOR PANIC DEVICES

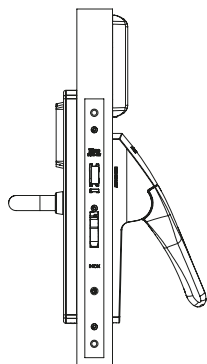

### Technical features

**FIRMWARE**  
1RIS

**RELEASE**  
2.0

**POWER UNIT**  
2 lithium batteries 3.6V type AA

**ESTIMATED BATTERY LIFE**  
Up to 2 years, up to 20.000 opening. The figure is dependent on the mode and environment of use and the options activated.

**ALERTS**  
- LEDs: 1 Green, 1 Red  
- Multi-frequency buzzer

**PRODUCT COMPATIBILITY**  
- Can be fit on any door (wooden, aluminium, metal, PVC and so on).  
- Door thickness 40 - 85 mm (with standard accessories),  
85 - 120 mm (with special accessories).  
- Suitable for use fire/smoke resisting door assemblies.  
- 7, 8 or 9 (\*) mm handle follower. Center distance follower/cylinder  
70, 72, 85, 88 and 92 mm.  
- Backset: 25mm minimum, if using nylon underplate to cover holes  
on door backset minimum 40mm. European profile cylinder hole.  
- Latchbolt only or automatic deadbolt function.  
- Max handle rotation angle 40°.

(\*) with adaptor

**MOUNTING**  
- On door

**ENVIRONMENTAL FEATURES**  
- IP55  
- IP54

**WORKING TEMPERATURE**  
-20°C ÷ +60°C

**STORAGE TEMPERATURE**  
-25°C ÷ +75°C

**PACKAGE**  
1 trim, 1 battery holder, 2 batteries, 2 mm hex key, instruction manual.  
NOTE: Handle follower and fixing screws set, adaptes kit plate,  
mechanical override cylinder and mechanical lock not included.

**ACCESSORIES (NOT INCLUDED)**  
- Handle follower and screws set (mandatory)  
- Override cylinder  
- Override keys set  
- Underplate  
- Lock  
- Adapter plate kit for panic devices installation

 Code configurator

 Accessories

#### DIMENSIONS

- Plate width: 38 mm;
- Plate length: 294 mm;
- Plate thickness: 17 mm;
- Handle length: 131 mm from plate center;

Weight  
1530 g

#### ONLINE CONTENT

 Web page

 Installation guide

 Data sheet

 Specifications

 Leaflet

## Aries 2.0 For custom handles

### ELECTRONIC TRIM SET FOR CUSTOM HANDLES

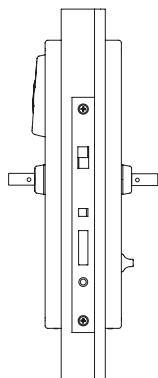

### Technical features

**FIRMWARE**  
1RIS

**RELEASE**  
2.0

**POWER UNIT**  
2 lithium batteries 3.6V type AA

**ESTIMATED BATTERY LIFE**  
Up to 2 years, up to 20.000 opening. The figure is dependent on the mode and environment of use and the options activated.

**ALERTS**  
- LEDs: 1 Green, 1 Red  
- Multi-frequency buzzer

**PRODUCT COMPATIBILITY**  
- Can be fit on any door (wooden, aluminium, metal, PVC and so on).  
- Door thickness 40 - 85 mm (with standard accessories), 85 - 120 mm (with special accessories).  
- Suitable for use fire/smoke resisting door assemblies.  
- 7, 8 or 9 (\*) mm handle follower. Center distance follower/cylinder 70, 72, 85, 88 and 92 mm.  
- Backset: 25mm minimum, if using nylon underplate to cover holes on door backset minimum 40mm. European profile cylinder hole.  
- Latchbolt only or automatic deadbolt function.  
- Max handle rotation angle 40°.

(\*) with adaptor

**MOUNTING**  
- On door

**ENVIRONMENTAL FEATURES**  
- IP55  
- IP54

**WORKING TEMPERATURE**  
-20°C ÷ +60°C

**STORAGE TEMPERATURE**  
-25°C ÷ +75°C

**PACKAGE**  
Industrial Packaging: 10 trims (pairs), 20 batteries, 2 mm hex key, instruction manual.

**NOTE:**  
- handles, handle follower and fixing screws set, mechanical override cylinder and mechanical lock not included.  
- For custom handle specifications, please see the corresponding document on [iseo.com](http://iseo.com)

**ACCESSORIES (NOT INCLUDED)**  
- Handle follower and screws set (mandatory)  
- Override cylinder  
- Override keys set  
- Underplate  
- Lock

 Code configurator

 Accessories

#### DIMENSIONS

- Plate width: 38 mm;
- Plate length: 294 mm;
- Plate thickness: 17 mm;

Weight  
1530 g

#### ONLINE CONTENT

 Web page

 Installation guide

 Data sheet

 Specifications

 Leaflet



## Aries 2.0 For custom handles for panic devices

### ELECTRONIC TRIM SET FOR PANIC DEVICES

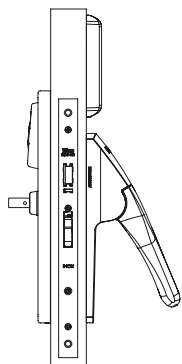

### Technical features

#### FIRMWARE

1RIS

#### RELEASE

2.0

#### POWER UNIT

2 lithium batteries 3.6V type AA

#### ESTIMATED BATTERY LIFE

Up to 2 years, up to 20.000 opening. The figure is dependent on the mode and environment of use and the options activated.

#### ALERTS

- LEDs: 1 Green, 1 Red
- Multi-frequency buzzer

#### PRODUCT COMPATIBILITY

- Can be fit on any door (wooden, aluminium, metal, PVC and so on).
- Door thickness 40 - 85 mm (with standard accessories), 85 - 120 mm (with special accessories).
- Suitable for use fire/smoke resisting door assemblies.
- 7, 8 or 9 (\*) mm handle follower. Center distance follower/cylinder 70, 72, 85, 88 and 92 mm.
- Backset: 25mm minimum, if using nylon underplate to cover holes on door backset minimum 40mm. European profile cylinder hole.
- Latchbolt only or automatic deadbolt function.
- Max handle rotation angle 40°.

(\*) with adaptor

#### MOUNTING

- On door

#### ENVIRONMENTAL FEATURES

- IP55
- IP54

#### WORKING TEMPERATURE

-20°C ÷ +60°C

#### STORAGE TEMPERATURE

-25°C ÷ +75°C

#### PACKAGE

Industrial Packaging: 10 trims, 10 battery holder, 20 batteries, 2 mm hex key, instruction manual.

#### NOTE:

- Internal and external handles, handle follower and fixing screws set, mechanical override cylinder and mechanical lock not included.
- For custom handle specifications, please see the corresponding document on [iseo.com](http://iseo.com)

#### ACCESSORIES (NOT INCLUDED)

- Handle follower and screws set (mandatory)
- Override cylinder
- Override keys set
- Underplate
- Lock
- Adapter plate kit for panic devices installation

 Code configurator

 Accessories

#### DIMENSIONS

- Plate width: 38 mm;
- Plate length: 294 mm;
- Plate thickness: 17 mm;

Weight  
1530 g

#### ONLINE CONTENT

 Web page

 Installation guide

 Data sheet

 Specifications

 Leaflet

## Aries 2.0 For DIN lock

### ELECTRONIC TRIM SET FOR DIN LOCK

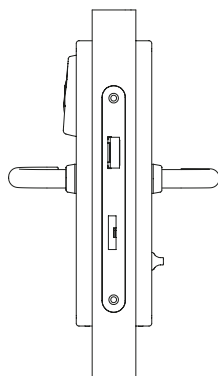

### Technical features

**FIRMWARE**  
1RIS

**RELEASE**  
2.0

**POWER UNIT**  
2 lithium batteries 3.6V type AA

**ESTIMATED BATTERY LIFE**  
Up to 2 years, up to 20.000 opening. The figure is dependent on the mode and environment of use and the options activated.

**ALERTS**  
- LEDs: 1 Green, 1 Red  
- Multi-frequency buzzer

**PRODUCT COMPATIBILITY**  
- Can be fit on any door (wooden, aluminium, metal, PVC and so on).  
- Door thickness 40 - 85 mm (with standard accessories), 85 - 120 mm (with special accessories).  
- Suitable for use fire/smoke resisting door assemblies.  
- 7, 8 or 9 (\*) mm handle follower. Center distance follower/cylinder 70, 72, 85, 88 and 92 mm.  
- Backset: 25mm minimum, if using nylon underplate to cover holes on door backset minimum 40mm. European profile cylinder hole.  
- Latchbolt only or automatic deadbolt function.  
- Max handle rotation angle 40°.

(\*) with adaptor

**MOUNTING**  
- On door

**ENVIRONMENTAL FEATURES**  
- IP55  
- IP54

**WORKING TEMPERATURE**  
-20°C ÷ +60°C

**STORAGE TEMPERATURE**  
-25°C ÷ +75°C

**PACKAGE**  
1 trim (pairs), 2 batteries, 2 mm hex key, instruction manual.  
NOTE: handle set, fastener screws, adapter plate kit, emergency cylinder and mechanical lock not included.

**ACCESSORIES (NOT INCLUDED)**  
- Handle follower and screws set (mandatory)  
- Override cylinder  
- Override keys set  
- Underplate  
- Lock  
- Adapter plate kit for DIN locks installation

 Code configurator

 Accessories

#### DIMENSIONS

- Plate width: 38 mm;
- Plate length: 294 mm;
- Plate thickness: 17 mm;
- Handle length: 131 mm from plate center;

Weight  
1530 g

#### ONLINE CONTENT

 Web page

 Installation guide

 Data sheet

 Specifications

 Leaflet

## Aries 2.0 For fire locks

### ELECTRONIC TRIM SET FOR FIRE LOCKS

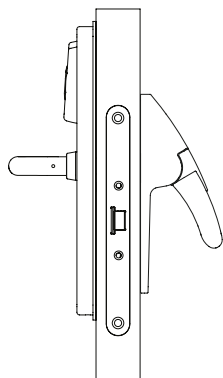

### Technical features

**FIRMWARE**  
1RIS

**RELEASE**  
2.0

**POWER UNIT**  
2 lithium batteries 3.6V type AA

**ESTIMATED BATTERY LIFE**  
Up to 2 years, up to 20.000 opening. The figure is dependent on the mode and environment of use and the options activated.

**ALERTS**

- LEDs: 1 Green, 1 Red
- Multi-frequency buzzer

**PRODUCT COMPATIBILITY**

- Can be fit on any door (wooden, aluminium, metal, PVC and so on).
- Door thickness 40 - 85 mm (with standard accessories), 85 - 120 mm (with special accessories).
- Suitable for use fire/smoke resisting door assemblies.
- 7, 8 or 9 (\*) mm handle follower. Center distance follower/cylinder 70, 72, 85, 88 and 92 mm.
- Backset: 25mm minimum, if using nylon underplate to cover holes on door backset minimum 40mm. European profile cylinder hole.
- Latchbolt only or automatic deadbolt function.
- Max handle rotation angle 40°.

(\*) with adaptor

**MOUNTING**  
- On door

**ENVIRONMENTAL FEATURES**

- IP54
- IP55

**WORKING TEMPERATURE**  
-20°C ÷ +60°C

**STORAGE TEMPERATURE**  
-25°C ÷ +75°C

**PACKAGE**  
1 trim, 1 adapter plate kit, 1 handle set, 2 batteries, fastener screws, 2 mm hex key, instruction manual.  
NOTE: mechanical lock and panic devices not included.

**ACCESSORIES (NOT INCLUDED)**

- Handle follower and screws set (mandatory)
- Override cylinder
- Override keys set
- Underplate
- Lock

 Code configurator

 Accessories

#### DIMENSIONS

- Plate width: 38 mm;
- Plate length: 294 mm;
- Plate thickness: 17 mm;
- Handle length: 131 mm from plate center;

Weight  
1530 g

#### ONLINE CONTENT

 Web page

 Installation guide

 Data sheet

 Specifications

 Leaflet

## Aries 2.0 For Premi Apri Meroni locks

### ELECTRONIC TRIM SET

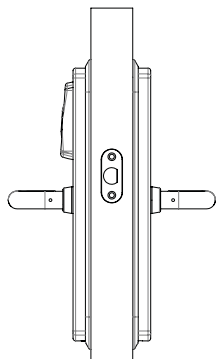

### Technical features

**FIRMWARE**  
1RIS

**RELEASE**  
2.0

**POWER UNIT**  
2 lithium batteries 3.6V type AA

**ESTIMATED BATTERY LIFE**  
Up to 2 years, up to 20.000 opening. The figure is dependent on the mode and environment of use and the options activated.

**ALERTS**  
- LEDs: 1 Green, 1 Red  
- Multi-frequency buzzer

**PRODUCT COMPATIBILITY**  
- Can be fit on any door (wooden, aluminium, metal, PVC and so on).  
- Door thickness 40 - 85 mm (with standard accessories), 85 - 120 mm (with special accessories).  
- Suitable for use fire/smoke resisting door assemblies.  
- 7, 8 or 9 (\*) mm handle follower. Center distance follower/cylinder 70, 72, 85, 88 and 92 mm.  
- Backset: 25mm minimum, if using nylon underplate to cover holes on door backset minimum 40mm. European profile cylinder hole.  
- Latchbolt only or automatic deadbolt function.  
- Max handle rotation angle 40°.

(\*) with adaptor

**MOUNTING**  
- On door

**ENVIRONMENTAL FEATURES**  
- IP54  
- IP55

**WORKING TEMPERATURE**  
-20°C ÷ +60°C

**STORAGE TEMPERATURE**  
-25°C ÷ +75°C

**PACKAGE**  
1 trim (pair) 1 plastic underplate, 2 batteries, 2 mm hex key, instruction manual.  
NOTE: handle set and fastener screws, override cylinder and mechanical lock not included.

**ACCESSORIES (NOT INCLUDED)**  
- Handle follower and screws set (mandatory)  
- Override cylinder  
- Override keys set  
- Underplate  
- Lock

 Code configurator

 Accessories

#### DIMENSIONS

- Plate width: 38 mm;
- Plate length: 294 mm;
- Plate thickness: 17 mm;
- Handle length: 131 mm from plate center;

Weight  
1530 g

#### ONLINE CONTENT

 Web page

 Installation guide

 Data sheet

 Specifications

 Leaflet

# Aries 2.0

## Accessories

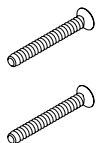

**SCREWS AND HANDLE FOLLOWER KIT**  
 2 screws M5 with threadlocking.  
 Package: 2 screws, 1 handle follower  
 NOTE: Select the right kit depending on door thickness.

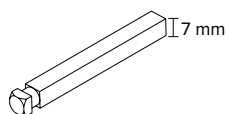

**QM 7 mm Spindle**

Door thickness <b>S</b> from 40 to 55 mm	1	201E074055A
Door thickness <b>S</b> from 55 to 70 mm	1	201E075570A
Door thickness <b>S</b> from 70 to 85 mm	1	201E077085A

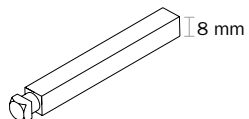

**QM 8 mm Spindle**

Door thickness <b>S</b> from 40 to 55 mm	1	201E004055A
Door thickness <b>S</b> from 55 to 70 mm	1	201E005570A
Door thickness <b>S</b> from 70 to 85 mm	1	201E007085A
Door thickness MAX 125 mm (to be cut)	1	201E008010A

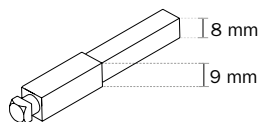

**QM 9 mm Spindle (for fire doors)**

Door thickness <b>S</b> from 40 to 55 mm	1	201E094055A
Door thickness <b>S</b> from 55 to 70 mm	1	201E095570A
Door thickness <b>S</b> from 70 to 85 mm	1	201E097085A
Door thickness <b>S</b> from 85 to 125mm	1	201E098010A

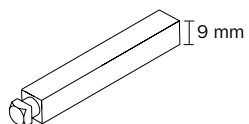

**SCREWS AND HANDLE FOLLOWERS KIT**  
 For panic devices installation.  
 Followers 9 mm and fixing screws for doors thickness up to 85 mm.  
 NOTE: to be cut according to door thickness

1	201E915570A
---	-------------

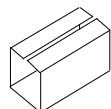

**ADAPTER FOR HANDLE FOLLOWER**  
 8 to 9 mm adapter

10	5060000900092
----	---------------

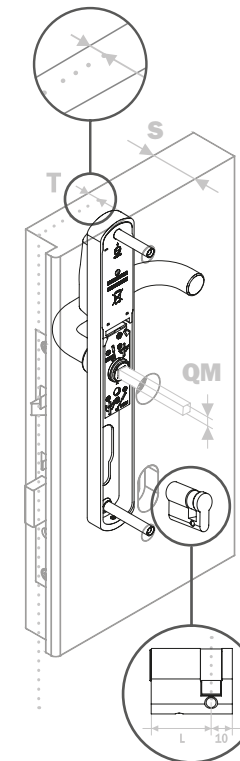



## Aries 2.0

### Accessories

#### ADAPTER PLATE KIT

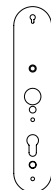

ADAPTER PLATE KIT  
 For panic devices installation with series 214\* panic lock case  
 (DIN 72 mm center distance).  
 Package: 1 adapter plate.

1 529E000040

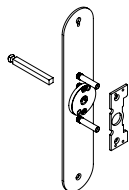

ADAPTER PLATE KIT  
 For RIM panic devices Idea Push installation  
 Package: plates, fixing screws, accessories.

1 567E0000540

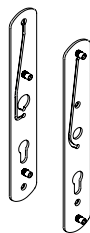

ADAPTER PLATE KIT  
 For DIN locks installation  
 Package: plates

1 529E080054

# Aries 2.0

## Accessories

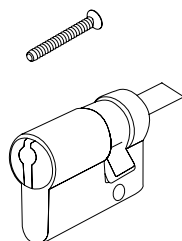

### OVERRIDE MECHANICAL CYLINDER

Monoprofile with usage detection plate. High Security ISEO R90 Factory.  
Up to 3 mechanical recodings. KA on the same installation. Nickel plated finish. Without keys.  
Package: 1 cylinder, 1 fixing screw

VISIBLE CYLINDER		HIDDEN CYLINDER	
08 < T < 13	L = 30 + 10 mm	17 < T < 27	L = 30 + 10 mm
13 < T < 23	L = 40 + 10 mm	27 < T < 37	L = 40 + 10 mm
23 < T < 33	L = 50 + 10 mm	37 < T < 47	L = 50 + 10 mm

S = door thickness (mm)

T = distance between front plate axis of symmetry of mechanical lock and the external door edge

NOTE: Select the right dimension depending on door and lock features.

Override keys to be ordered separately.

Lenght L 30 - 10 mm	1	82RC030A19RF.08
Lenght L 40 - 10 mm	1	82RC040A19RF.08
Lenght L 50 - 10 mm	1	82RC050A19RF.08

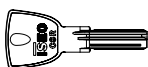

### OVERRIDE KEYS KIT

3 R90 keys in sequence.

Property cards.

Package: 3 keys, 2 property cards

	1	80RCKR0F0
--	---	-----------

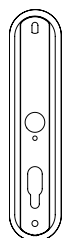

### PLASTIC UNDERPLATE

Black plastic underplate to cover up eventually visible key holes.

Dimensions: H=312 mm, L=70 mm.

Package: 1 underplate.

	1	529E00000
--	---	-----------

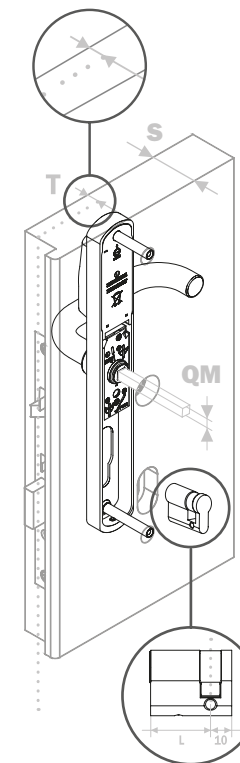

# Aries 2.0

## Accessories

### AESTHETIC EXTERNAL AND INTERNAL COVER

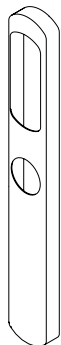

**AESTHETIC EXTERNAL COVER**  
Without cylinder hole in the cover.  
Package: 1 cover

Inox	1	561E1120240
------	---	-------------

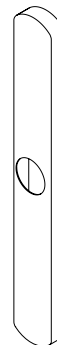

**AESTHETIC INTERNAL COVER**  
Without privacy.  
Package: 1 cover

Inox	1	561E1130240
------	---	-------------



**AESTHETIC EXTERNAL COVER**  
With cylinder hole.  
Package: 1 cover

70 mm center distance

Inox	1	561E1420240
------	---	-------------

72 mm center distance

Inox	1	561E1520240
------	---	-------------

85 mm center distance

Inox	1	561E1220240
------	---	-------------

88 mm center distance

Inox	1	561E1620240
------	---	-------------

92 mm center distance

Inox	1	561E1320240
------	---	-------------

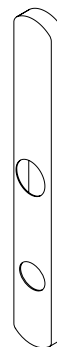

**AESTHETIC INTERNAL COVER**  
With privacy.  
Package: 1 cover

Inox	1	561E1330240
------	---	-------------

## Aries 2.0

---

### Accessories

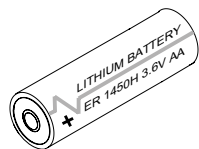

### BATTERY

#### BATTERY

High current lythium battery.

Size AA, 3,6Vcc.

10

58200000E0360

---

# Aries 2.0

## Accessories

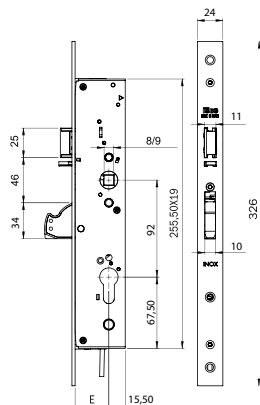

## LOCK CAN BE COMBINED (1/3)

### MULTIBLINDO EASY EXIT LATERAL.

Automatic lock with emergency function to be used with Aries.  
 Locking: deadbolt automatic relocking when the door is closed.  
 Opening: latchbolt and deadbolt operated by the handle or the key.  
 Center distance 92 mm. The microswitch detects and signals the deadbolt status.  
 Right or left latchbolt, non reversible. To be ordered separately: striking plates 03323\*.  
 Package: 1 lock, instructions.

ONE-PIECE HANDLE FOLLOWER 9 mm  
 8/9 mm square spindle code 201E094055A included.

Flat front-plate	Backset mm			
326x24x3	INOX	35 DIN SX	1	7A19163522S.A
		35 DIN DX	1	7A19163522D.A
	40 DIN SX	1	7A19164022S.A	
	40 DIN DX	1	7A19164022D.A	
	45 DIN SX	1	7A19164522S.A	
	45 DIN DX	1	7A19164522D.A	
	50 DIN SX	1	7A19165022S.A	
	50 DIN DX	1	7A19165022D.A	
	55 DIN SX	1	7A19165522S.A	
	55 DIN DX	1	7A19165522D.A	
	60 DIN SX	1	7A19166022S.A	
	60 DIN DX	1	7A19166022D.A	
	65 DIN SX	1	7A19166522S.A	
	65 DIN DX	1	7A19166522D.A	

ONE-PIECE HANDLE FOLLOWER 8 mm

Flat front-plate	Backset mm			
326x24x3	INOX	35 DIN SX	1	7A12163522S.A
		35 DIN DX	1	7A12163522D.A
	40 DIN SX	1	7A12164022S.A	
	40 DIN DX	1	7A12164022D.A	
	45 DIN SX	1	7A12164522S.A	
	45 DIN DX	1	7A12164522D.A	
	50 DIN SX	1	7A12165022S.A	
	50 DIN DX	1	7A12165022D.A	
	55 DIN SX	1	7A12165522S.A	
	55 DIN DX	1	7A12165522D.A	
	60 DIN SX	1	7A12166022S.A	
	60 DIN DX	1	7A12166022D.A	
	65 DIN SX	1	7A12166522S.A	
	65 DIN DX	1	7A12166522D.A	

# Aries 2.0

## Accessories

### LOCK CAN BE COMBINED (2/3)

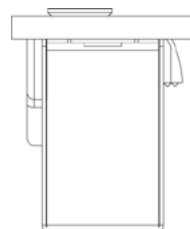

Full-size scale

ADJUSTABLE closed striking plate for CENTRAL LOCK  
 MULTIBLINDO EASY.

Material: stainless steel.

With mechanical striker.

Flat front-plate 24x3x220 DIN SX

10 033230

Flat front-plate 24x3x220 DIN DX

10 033231

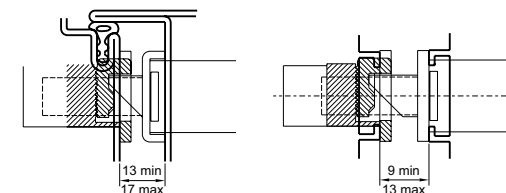
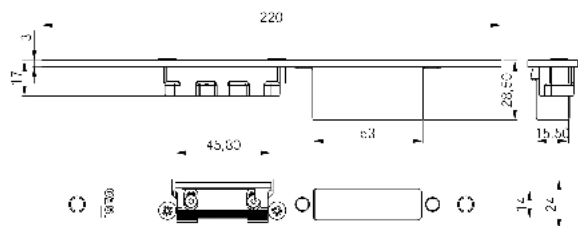

In case the space between the striking plate and the door is greater, it is necessary to use a spacer for the striking plate

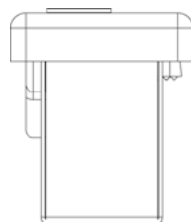

Full-size scale

ADJUSTABLE closed striking plate for CENTRAL LOCK  
 MULTIBLINDO EASY.

Material: stainless steel.

With mechanical striker.

U-front plate 24x6x220 DIN SX

10 033232

U-front plate 24x6x220 DIN DX

10 033233

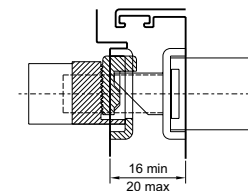
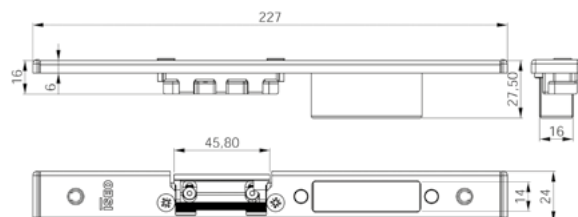

In case the space between the striking plate and the door is greater, it is necessary to use a spacer for the striking plate



## Aries 2.0

### Accessories

#### LOCK CAN BE COMBINED (3/3)

##### AUTOMATIC MECHANICAL LOCK

Mortise lock, automatic deadbolt function (18 mm extension)

Panic exit function, splitted latchbolt, equipped with devices against forced entry (reversible).

Backset: 55 mm, center distance: 85 mm, 8 mm handle follower

Chrome plated, squared/rounded frontplate

Package: 1 lock, 1 striking plate.

Squared frontplate	1	207553.Z
Rounded frontplate	1	217553.Z

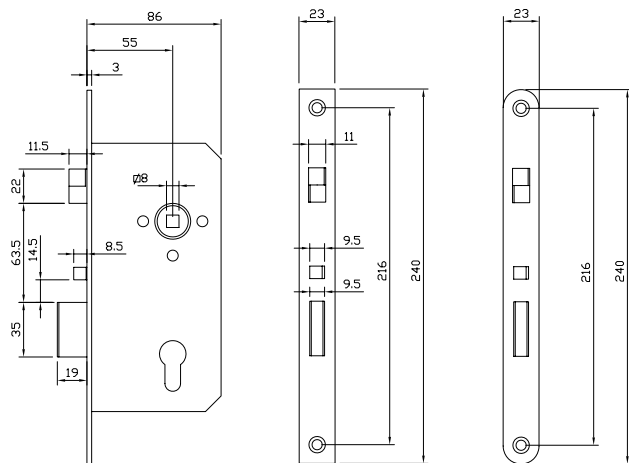

# Locker 2.0

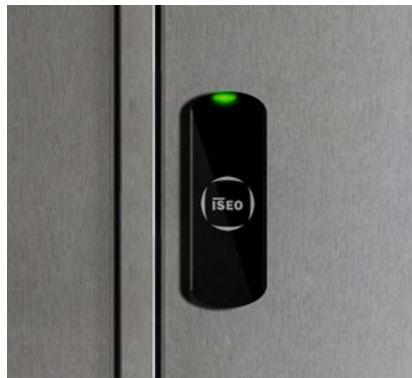

## For office, gym, swimming pool

Locker can be installed on a wide range of cabinets and lockers in order to keep people's property safe while they're in the office, the gym, swimming pool, or any other situation where personal belongings need to be temporarily safeguarded.

## Automatic locking

By closing the door of the cabinet, Locker will automatically lock.  
Locker is battery powered allowing easy installation in new lockers or retrofit in existing lockers currently operated by keys.

## Product features

- Automatic locking just pulling the door ajar
- Battery-operated device with charge status detection
- Wake up by RFID card detection or phone (patented)
- Low energy consumption device
- Real Time Clock/Calendar
- Four-eye principle (two valid credentials must be presented in sequence to open the lock)
- Anti passback function
- Light and acoustic signals
- Permanently open mode (office mode) without no extra battery consumption
- Software upgradeable on-site via Bluetooth® phone (Stand Alone)

### FINISH

 Technopolymer

### COLOR

 Anthracite

### ENVIRONMENTAL FEATURES

- IP20

### ACCESS CREDENTIALS

- Badge
- Keyfob
- Bracelet
- Smartphone

### COMMUNICATION INTERFACE

- RFID ISO14443B/Mifare ISO14443A
- Bluetooth® Low Energy 5.1

Go to page

### MODELS

→ [Electronic lock for cabinets](#) p. 52

## Locker 2.0 Electronic lock for cabinets

LOCKER CAN BE INSTALLED ON A WIDE RANGE OF CABINETS AND LOCKERS IN ORDER TO PROTECT USERS' BELONGINGS

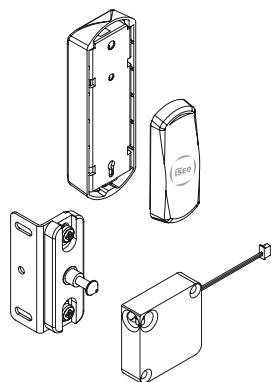

### Technical features

**FIRMWARE**  
1RIS

**RELEASE**  
2.0

**PRODUCT COMPATIBILITY**

- Locker can be installed on a wide range of cabinets and lockers in order to protect users' belongings while they are in office, gym, swimming pool or in every similar situation where people need to deposit personal items in a secure place.

**WORKING TEMPERATURE**  
-20°C ÷ +60°C

**STORAGE TEMPERATURE**  
-25°C ÷ +75°C

**PACKAGE**

1 cylinder, 1 battery, cylinder fixing screw, 2 mm hex key, instruction sheet

**ACCESSORIES (NOT INCLUDED)**

- Battery (58200000E0360)
- Accessori for electric emergency (0000IS00253)

cod. 1EL10152



**DIMENSIONS**

External dimensions:

- Width: 39mm
- Height: 86mm

Internal dimensions:

- Width: 40mm
- Height: 130mm

**ONLINE CONTENT**

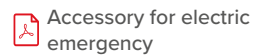
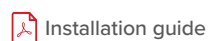

# Locker 2.0

---

## Accessories

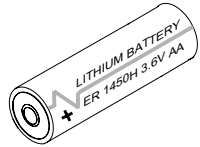

**BATTERY**  
 High current lythium battery  
 Size AA, 3.6 Vcc

10 58200000E0360

---



**ACCESSORY FOR ELECTRIC EMERGENCY**  
 Package: 1 battery holder.  
 NOTE: BATTERIES NON INCLUDED.

1 0000IS00253

---

# Libra LE60 2.1

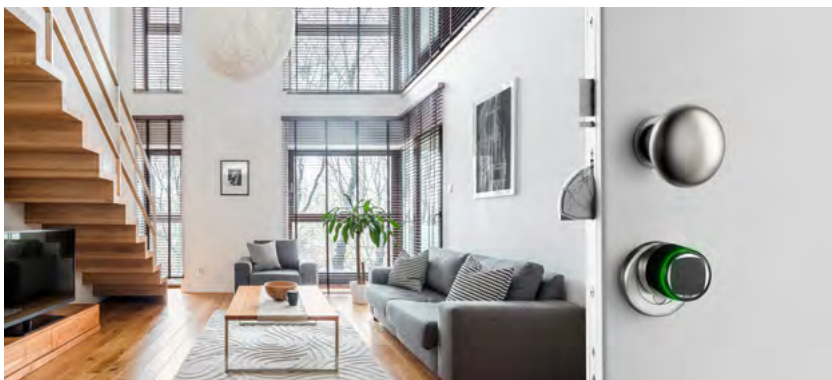



## Suitable for various applications

Thanks to the quick and easy installation, the electronic modular cylinder LIBRA is the ideal and universal solution both for the replacement of mechanical European profile cylinders and for installation on new doors.

## Simple to install

It is battery operated, so it doesn't require any electrical external cabling. The result is the best flexibility and cost effectiveness of installation, both in new doors and in retrofitting.

### FINISH

-  Stainless
-  Polished chrome
-  Polished brass

### COLOR

-  Black
-  White
-  Metal grey

## Product's functions

- Battery-operated device with charge status detection
- Wake up by RFID card detection or phone (patented)
- Low energy consumption device
- Permanently open mode (office mode) without no extra battery consumption
- Anti passback function
- Real Time Clock/Calendar
- Software upgradeable on-site via Bluetooth® phone (Stand Alone)
- Light and acoustic signals
- Four-eye principle (two valid credentials must be presented in sequence to open the lock)

Go to page

### MODELS

- Standard p. 56
- Premium p. 57
- Half p. 58
- Double p. 59
- Removable reader and Extension plug 16 mm p. 60
- Removable reader and Extension plug 75 mm p. 61
- Dummy-knob p. 62
- Oval Australian p. 63
- Oval Scandinavian p. 64

### ENVIRONMENTAL FEATURES

- IP66
- IP67
- IP68
- IP69

### ACCESS CREDENTIALS

- Badge
- Keyfob
- Bracelet
- Smartphone

### COMMUNICATION INTERFACE

- RFID ISO14443B/Mifare ISO14443A
- Bluetooth® Low Energy 5.1

### CERTIFICATIONS

- EN15684:2013-01 Standard Duty version 16B4AF30 on specific models
- EN15684:2013-01 Heavy Duty version 16B4AF30 on specific models
- SKG\*\*\* for HD (Heavy Duty) version

# Libra LE60 2.1

## Selection guide

The LIBRA electronic modular cylinder represents the ideal and universal solution for access control both for retrofit installations to replace of mechanical European profile cylinders (in addition to the Australian and Scandinavian oval cylinder versions), and for installations on new doors.

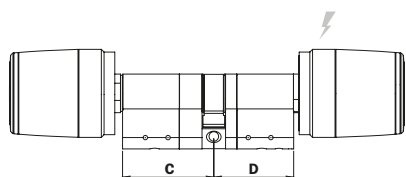

## ORDER THE PRODUCT IN A FEW STEPS

1

**Check the door type and the dimensions of the cylinder (in the case of replacement on an existing door).**

2

**Choose the Libra model** in the column on the right, generating the code thanks to the configurator on the product page.

3

### Optional.

See accessory sheets for modifications and component replacements.

### Choose from menu

- [Pre-assembled modules](#)
- [Modular Libra assembled components](#)
- [Electronic knob spare parts](#)
- [Premium knob cover \(RFID and mechanical version\)](#)
- [Standard mechanical knob](#)
- [Anti-intrusion accessories](#)
- [Assembly/Disassembly tooling kit](#)
- [Assembly tooling kit for modular cylinders](#)
- [Packaging design](#)

Go to page

### ● SELECTION GUIDE

#### MODELS

- Standard p. 56
- Premium p. 57
- Half p. 58
- Double p. 59
- Removable reader and Extension plug 16 mm p. 60
- Removable reader and Extension plug 75 mm p. 61
- Dummy-knob p. 62
- Oval Australian p. 63
- Oval Scandinavian p. 64

## Libra LE60 2.1 Standard

### MODULAR CYLINDER WITH EXTERNAL ELECTRONIC KNOB (FREE ROTATION) AND INTERNAL MECHANICAL KNOB (STANDARD TYPE)

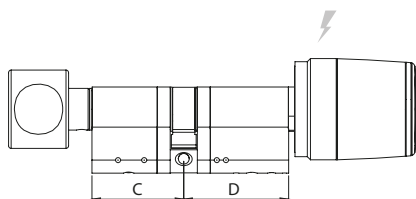

### Technical features

**FIRMWARE**  
1RIS

**RELEASE**  
2.1

**POWER UNIT**  
1.3V lithium battery type CR123

**ESTIMATED BATTERY LIFE**  
Up to 2 years, up to 20.000 opening.  
The figure is dependent on the mode and environment of use and the options activated.

**ALERTS**  
- LEDs: 1 Green, 1 Red  
- Multi-frequency buzzer

**PRODUCT COMPATIBILITY**  
- Compatible with all the mechanical locks equipped with an European profile cylinder hole (EN1303, DIN 18252)

**MOUNTING**  
- On door

#### ENVIRONMENTAL FEATURES

- IP66
- IP67
- IP68
- IP69

#### WORKING TEMPERATURE

-20°C ÷ +70°C

#### STORAGE TEMPERATURE

-25°C ÷ +75°C

#### PACKAGE

1 cylinder, 1 battery, cylinder fixing screw, 2 mm hex key, instruction sheet

#### ACCESSORIES (NOT INCLUDED)

- Pre-assembled modules
- Assembled components Modular Libra
- Electronic knob spare parts
- Premium knob cover (RFID and mechanical version)
- Standard mechanical knob
- Anti-theft accessories
- Tool set for assembly/disassembly
- Modular cylinder mounting fixture
- Design packs

 Code configurator

 Accessories

#### DIMENSIONS

Electronic knob dimensions:

- External diameter from 36 to 39 mm
- Length: 46mm

"Standard" mechanical knob dimensions:

- Outer diameter 30mm
- Length: 31mm

#### ONLINE CONTENT

 Web page

 Data sheet

 Leaflet

 Installation guide

 Specifications

 Libra tooling kit

 Libra warnings



## Libra LE60 2.1 Premium

### MODULAR CYLINDER WITH EXTERNAL ELECTRONIC KNOB (FREE ROTATION) AND INTERNAL MECHANICAL KNOB (PREMIUM TYPE)

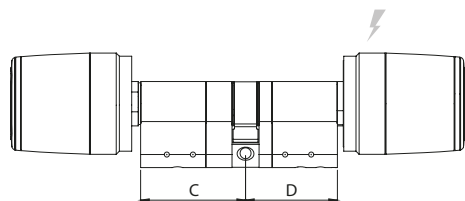

### Technical features

**FIRMWARE**  
1RIS

**RELEASE**  
2.1

**POWER UNIT**  
1.3V lithium battery type CR123

**ESTIMATED BATTERY LIFE**  
Up to 2 years, up to 20.000 opening.  
The figure is dependent on the mode and environment of use and the options activated.

**ALERTS**  
- LEDs: 1 Green, 1 Red  
- Multi-frequency buzzer

**PRODUCT COMPATIBILITY**  
- Compatible with all the mechanical locks equipped with an European profile cylinder hole (EN1303, DIN 18252)

**MOUNTING**  
- On door

### ENVIRONMENTAL FEATURES

- IP66
- IP67
- IP68
- IP69

### WORKING TEMPERATURE

-20°C ÷ +70°C

### STORAGE TEMPERATURE

-25°C ÷ +75°C

### PACKAGE

1 cylinder, 1 battery, cylinder fixing screw, 2 mm hex key, instruction sheet

### ACCESSORIES (NOT INCLUDED)

- Pre-assembled modules
- Assembled components Modular Libra
- Electronic knob spare parts
- Premium knob cover (RFID and mechanical version)
- Standard mechanical knob
- Anti-theft accessories
- Tool set for assembly/disassembly
- Modular cylinder mounting fixture
- Design packs

 Code configurator

 Accessories

### DIMENSIONS

Electronic knob dimensions:

- External diameter from 36 to 39 mm
- Length: 46mm

"Premium" mechanical knob dimensions:

- External diameter from 36 to 39 mm
- Length: 46mm

### ONLINE CONTENT

 Web page

 Data sheet

 Leaflet

 Installation guide

 Specifications

 Libra tooling kit

 Libra warnings

## Libra LE60 2.1 Half

### MODULAR HALF KNOB CYLINDER WITH EXTERNAL ELECTRONIC KNOB (FREE-ROTATING)

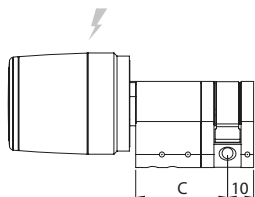

### Technical features

#### FIRMWARE

1RIS

#### RELEASE

2.1

#### POWER UNIT

1 3V lithium battery type CR123

#### ESTIMATED BATTERY LIFE

Up to 2 years, up to 20.000 opening.

The figure is dependent on the mode and environment of use and the options activated.

#### ALERTS

- LEDs: 1 Green, 1 Red
- Multi-frequency buzzer

#### PRODUCT COMPATIBILITY

- Compatible with all the mechanical locks equipped with an European profile cylinder hole (EN1303, DIN 18252)

#### MOUNTING

- On door

#### ENVIRONMENTAL FEATURES

- IP66
- IP67
- IP68
- IP69

#### WORKING TEMPERATURE

-20°C ÷ +70°C

#### STORAGE TEMPERATURE

-25°C ÷ +75°C

#### PACKAGE

1 cylinder, 1 battery, cylinder fixing screw, 2 mm hex key, instruction sheet

#### ACCESSORIES (NOT INCLUDED)

- Pre-assembled modules
- Assembled components Modular Libra
- Electronic knob spare parts
- Premium knob cover (RFID and mechanical version)
- Standard mechanical knob
- Anti-theft accessories
- Tool set for assembly/disassembly
- Modular cylinder mounting fixture
- Design packs

 Code configurator

 Accessories

#### DIMENSIONS

Electronic knob dimensions:

- External diameter from 36 to 39 mm
- Length: 46mm

#### ONLINE CONTENT

 Web page

 Installation guide

 Libra warnings

 Data sheet

 Specifications

 Leaflet

 Libra tooling kit

## Libra LE60 2.1 Double

MODULAR CYLINDER WITH EXTERNAL ELECTRONIC KNOB (FREE-ROTATING) AND INTERNAL ELECTRONIC KNOB (FREE-ROTATING)

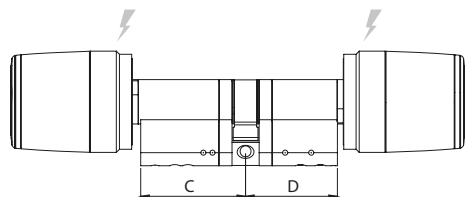

### Technical features

**FIRMWARE**  
1RIS

**RELEASE**  
2.1

**POWER UNIT**  
1.3V lithium battery type CR123

**ESTIMATED BATTERY LIFE**  
Up to 2 years, up to 20.000 opening.  
The figure is dependent on the mode and environment of use and the options activated.

**ALERTS**  
- LEDs: 1 Green, 1 Red  
- Multi-frequency buzzer

**PRODUCT COMPATIBILITY**  
- Compatible with all the mechanical locks equipped with an European profile cylinder hole (EN1303, DIN 18252)

**MOUNTING**  
- On door

### ENVIRONMENTAL FEATURES

- IP66
- IP67
- IP68
- IP69

### WORKING TEMPERATURE

-20°C ÷ +70°C

### STORAGE TEMPERATURE

-25°C ÷ +75°C

### PACKAGE

1 cylinder, 2 battery, cylinder fixing screw, 2 mm hex key, instruction sheet

### ACCESSORIES (NOT INCLUDED)

- Pre-assembled modules
- Assembled components Modular Libra
- Electronic knob spare parts
- Premium knob cover (RFID and mechanical version)
- Standard mechanical knob
- Anti-theft accessories
- Tool set for assembly/disassembly
- Modular cylinder mounting fixture
- Design packs

 Code configurator

 Accessories

### DIMENSIONS

Electronic knob dimensions:

- External diameter from 36 to 39 mm
- Length: 46mm

### ONLINE CONTENT

 Web page

 Data sheet

 Leaflet

 Installation guide

 Specifications

 Libra tooling kit

 Libra warnings

## Libra LE60 2.1 Removable reader and Extension plug 16 mm

MODULAR CYLINDER FOR ARMORED DOORS WITH EXTERNAL ELECTRONIC KNOB (FREE ROTATION), COMPATIBLE WITH CYLINDERS ESCUTCHEON, EXTENSION PLUG AND PRE-ARRANGED FOR INTERNAL KNOB SHAFT D 8X16 MM

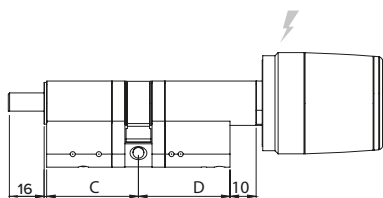

### Technical features

**FIRMWARE**  
1RIS

**RELEASE**  
2.1

**POWER UNIT**  
1.3V lithium battery type CR123

**ESTIMATED BATTERY LIFE**  
Up to 2 years, up to 20.000 opening.  
The figure is dependent on the mode and environment of use and the options activated.

**ALERTS**  
- LEDs: 1 Green, 1 Red  
- Multi-frequency buzzer

**PRODUCT COMPATIBILITY**  
- Compatible with all the mechanical locks equipped with an European profile cylinder hole (EN1303, DIN 18252)

**MOUNTING**  
- On door

### ENVIRONMENTAL FEATURES

- IP66
- IP67
- IP68
- IP69

### WORKING TEMPERATURE

-20°C ÷ +70°C

### STORAGE TEMPERATURE

-25°C ÷ +75°C

### PACKAGE

1 cylinder, 1 battery, cylinder fixing screw, 2 mm hex key, instruction sheet

### ACCESSORIES (NOT INCLUDED)

- Pre-assembled modules
- Assembled components Modular Libra
- Electronic knob spare parts
- Premium knob cover (RFID and mechanical version)
- Standard mechanical knob
- Anti-theft accessories
- Tool set for assembly/disassembly
- Modular cylinder mounting fixture
- Design packs

 Code configurator

 Accessories

### DIMENSIONS

Electronic knob dimensions:

- External diameter from 36 to 39 mm
- Length: 46mm

### ONLINE CONTENT

 Web page

 Data sheet

 Leaflet

 Installation guide

 Specifications

 Libra tooling kit

 Libra warnings

## Libra LE60 2.1 Removable reader and Extension plug 75 mm

MODULAR CYLINDER FOR ARMORED DOORS WITH EXTERNAL ELECTRONIC KNOB (FREE ROTATION), COMPATIBLE WITH CYLINDERS ESCUTCHEON, EXTENSION PLUG AND PRE-ARRANGED FOR INTERNAL KNOB SHAFT D 8X75 MM

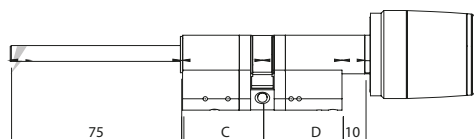

### Technical features

**FIRMWARE**  
1RIS

**RELEASE**  
2.1

**POWER UNIT**  
1.3V lithium battery type CR123

**ESTIMATED BATTERY LIFE**  
Up to 2 years, up to 20.000 opening.  
The figure is dependent on the mode and environment of use and the options activated.

**ALERTS**  
- LEDs: 1 Green, 1 Red  
- Multi-frequency buzzer

**PRODUCT COMPATIBILITY**  
- Compatible with all the mechanical locks equipped with an European profile cylinder hole (EN1303, DIN 18252)

**MOUNTING**  
- On door

### ENVIRONMENTAL FEATURES

- IP66
- IP67
- IP68
- IP69

### WORKING TEMPERATURE

-20°C ÷ +70°C

### STORAGE TEMPERATURE

-25°C ÷ +75°C

### PACKAGE

1 cylinder, 1 battery, cylinder fixing screw, 2 mm hex key, instruction sheet

### ACCESSORIES (NOT INCLUDED)

- Pre-assembled modules
- Assembled components Modular Libra
- Electronic knob spare parts
- Premium knob cover (RFID and mechanical version)
- Standard mechanical knob
- Anti-theft accessories
- Tool set for assembly/disassembly
- Modular cylinder mounting fixture
- Design packs

 Code configurator

 Accessories

### DIMENSIONS

Electronic knob dimensions:

- External diameter from 36 to 39 mm
- Length: 46mm

### ONLINE CONTENT

 Web page

 Data sheet

 Leaflet

 Installation guide

 Specifications

 Libra tooling kit

 Libra warnings

## Libra LE60 2.1 Dummy-knob

MODULAR CYLINDER FOR ARMORED DOORS  
WITH EXTERNAL ELECTRONIC KNOB (FREE ROTATION)  
AND KNOB-DUMMY ON INTERNAL SIDE

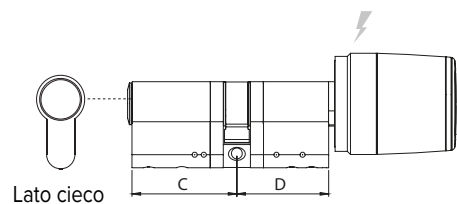

### Technical features

**FIRMWARE**  
1RIS

**RELEASE**  
2.1

**POWER UNIT**  
1 3V lithium battery type CR123

**ESTIMATED BATTERY LIFE**  
Up to 2 years, up to 20.000 opening.  
The figure is dependent on the mode and environment  
of use and the options activated.

**ALERTS**  
- LEDs: 1 Green, 1 Red  
- Multi-frequency buzzer

**PRODUCT COMPATIBILITY**  
- Compatible with all the mechanical locks equipped with an  
European profile cylinder hole (EN1303, DIN 18252)

**MOUNTING**  
- On door

### ENVIRONMENTAL FEATURES

- IP66
- IP67
- IP68
- IP69

### WORKING TEMPERATURE

-20°C ÷ +70°C

### STORAGE TEMPERATURE

-25°C ÷ +75°C

### PACKAGE

1 cylinder, 1 battery, cylinder fixing screw, 2 mm hex key,  
instruction sheet

### ACCESSORIES (NOT INCLUDED)

- Pre-assembled modules
- Assembled components Modular Libra
- Electronic knob spare parts
- Premium knob cover (RFID and mechanical version)
- Standard mechanical knob
- Anti-theft accessories
- Tool set for assembly/disassembly
- Modular cylinder mounting fixture
- Design packs

 Code configurator

 Accessories

### DIMENSIONS

Electronic knob dimensions:

- External diameter from 36 to 39 mm
- Length: 46mm

### ONLINE CONTENT

 Web page

 Data sheet

 Leaflet

 Installation guide

 Specifications

 Libra tooling kit

 Libra warnings

## Libra LE60 2.1 Oval Australian

### OVAL AUSTRALIAN ELECTRONIC CYLINDER WITH EXTERNAL ELECTRONIC KNOB (FREE ROTATION)

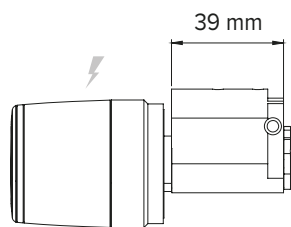

### Technical features

**FIRMWARE**  
1RIS

**RELEASE**  
2.1

**POWER UNIT**  
1 3V lithium battery type CR123

**ESTIMATED BATTERY LIFE**  
Up to 2 years, up to 20.000 opening.  
The figure is dependent on the mode and environment of use and the options activated.

**ALERTS**  
- LEDs: 1 Green, 1 Red  
- Multi-frequency buzzer

**PRODUCT COMPATIBILITY**  
- Compatible with all the mechanical locks equipped with an Australian profile cylinder hole

**MOUNTING**  
- On door

### ENVIRONMENTAL FEATURES

- IP66
- IP67
- IP68
- IP69

### WORKING TEMPERATURE

-20°C ÷ +70°C

### STORAGE TEMPERATURE

-25°C ÷ +75°C

### PACKAGE

1 cylinder, 1 battery, 2 mm hex key, instruction sheet

### ACCESSORIES (NOT INCLUDED)

- Pre-assembled modules
- Assembled components Modular Libra
- Electronic knob spare parts
- Premium knob cover (RFID and mechanical version)
- Standard mechanical knob
- Anti-theft accessories
- Tool set for assembly/disassembly
- Modular cylinder mounting fixture
- Design packs

 Code configurator

 Accessories

### DIMENSIONS

Electronic knob dimensions:

- External diameter from 36 to 39 mm
- Length: 46mm

### ONLINE CONTENT

 Web page

 Installation guide

 Libra warnings

 Data sheet

 Specifications

 Leaflet

 Libra tooling kit

## Libra LE60 2.1 Oval Scandinavian

### OVAL SCANDINAVIAN ELECTRONIC CYLINDER WITH EXTERNAL ELECTRONIC KNOB (FREE ROTATION)

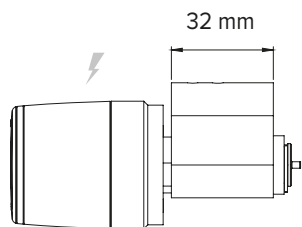

### Technical features

#### FIRMWARE

1RIS

#### RELEASE

2.1

#### POWER UNIT

1 3V lithium battery type CR123

#### ESTIMATED BATTERY LIFE

Up to 2 years, up to 20.000 opening.

The figure is dependent on the mode and environment of use and the options activated.

#### ALERTS

- LEDs: 1 Green, 1 Red
- Multi-frequency buzzer

#### PRODUCT COMPATIBILITY

- Compatible with all the mechanical locks equipped with a Scandinavian profile cylinder hole

#### MOUNTING

- On door

#### ENVIRONMENTAL FEATURES

- IP66
- IP67
- IP68
- IP69

#### WORKING TEMPERATURE

-20°C ÷ +70°C

#### STORAGE TEMPERATURE

-25°C ÷ +75°C

#### PACKAGE

1 cylinder, 1 battery, cylinder fixing screws for internal door side versions, 2 mm hex key, instruction sheet

#### ACCESSORIES (NOT INCLUDED)

- Pre-assembled modules
- Assembled components Modular Libra
- Electronic knob spare parts
- Premium knob cover (RFID and mechanical version)
- Standard mechanical knob
- Anti-theft accessories
- Tool set for assembly/disassembly
- Modular cylinder mounting fixture
- Design packs

 Code configurator

 Accessories

#### DIMENSIONS

Electronic knob dimensions:

- External diameter from 36 to 39 mm
- Length: 46mm

#### ONLINE CONTENT

 Web page

 Installation guide

 Libra warnings

 Data sheet

 Specifications

 Leaflet

 Libra tooling kit



# Libra LE60 2.1

## Accessories

### PRE-ASSEMBLED MODULES (1/3)

#### EXTERNAL WITHOUT COVER.

Multistandard RFID reader (ISO14443A/ISO14443B 13,56 Mhz) on the outside.

IP protection degree IP66/IP67/IP68/IP69 for all versions. Available Heavy Duty version with drilling protection.

2 finishes available.

Packaging: 1 knob, 1 battery, fixing screw.

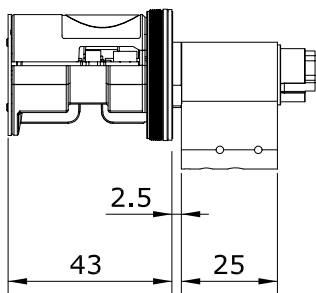

Electronic standard knob external side.

Nickel	1	8MK20K0009062
Brass	1	8MK20K0007062

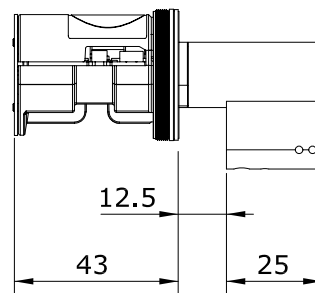

Electronic Heavy Duty knob external side removable

Nickel	1	8MK30K0009062
Brass	1	8MK30K0007062

NOTE: to be coupled only with internal module for armoured door

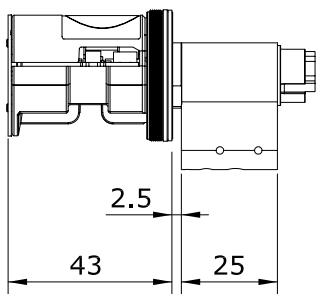

Electronic Heavy Duty knob outer side.

Nickel	1	8MK10K0009062
Brass	1	8MK10K0007062

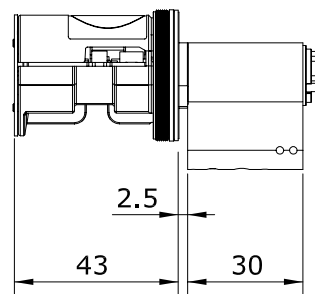

Electronic Heavy Duty knob external side removable.

Nickel	1	8MK40K0009062
Brass	1	8MK40K0007062

NOTE: to be coupled only with internal module for armoured door

## Libra LE60 2.1

### Accessories

### PRE-ASSEMBLED MODULES (2/3)

#### INTERNAL WITHOUT COVER.

Multistandard RFID reader (ISO14443A/ISO14443B 13,56 Mhz) on the inside.

IP protection degree IP66/IP67/IP68/IP69 for all versions.

2 finishes available.

Packaging: 1 knob, 1 battery, fixing screw.

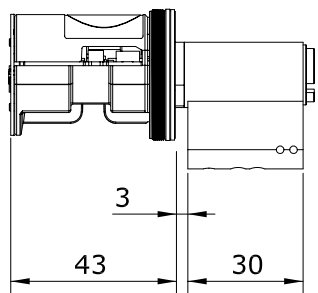

Electronic knob inside 35 mm.

Nickel	1	8MK20K1009062
Brass	1	8MK20K1007062

# Libra LE60 2.1

## Accessories

### PRE-ASSEMBLED MODULES (3/3)

INTERNAL WITHOUT KNOB.  
 2 finishes available.  
 Packaging: 1 module.

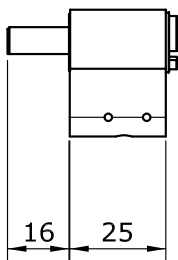

Shaft internal module 16 mm.

Nickel	1	8MK26K1009000
Brass	1	8MK26K1007000

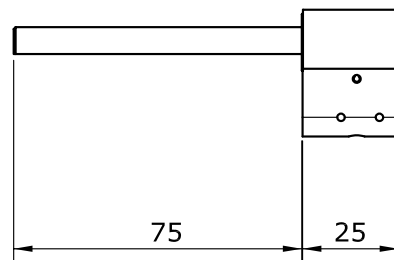

Shaft internal module 75 mm for armored door

Nickel	1	8MK3DK1009000
Brass	1	8MK3DK1007000

NOTE: to be coupled only with external module for armored door

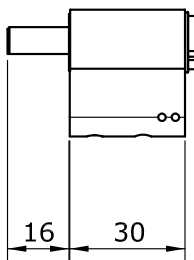

Shaft internal module 16 mm. For Panic.

Nickel	1	8MK26K1009000P
Brass	1	8MK26K1007000P

NOTE: to be coupled only with external module for armored door

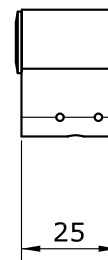

Module internal side for blind version: Libra LE60 Dummy Knob.

Nickel	1	8MK2CK1009000
Brass	1	8MK2CK1007000

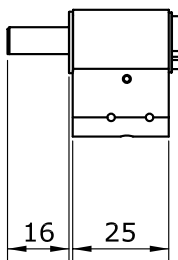

Shaft internal module 16 mm for armored door.

Nickel	1	8MK36K1009000
Brass	1	8MK36K1007000

NOTE: to be coupled only with external module for armored door

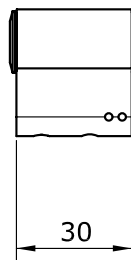

Module internal side for blind version: Libra LE60 Dummy Knob.

For Panic.		
Nickel	1	8MK2CK1009000P
Brass	1	8MK2CK1007000P

# Libra LE60 2.1

## Accessories

### MODULAR LIBRA ASSEMBLED COMPONENTS

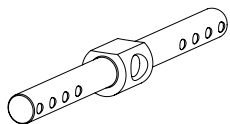

Kit 5 pcs. connecting bar for double cylinder.

3030 / 3035 / 3535	0033230
3040 / 3045 / 3540 / 3545	0033240
4040 / 4045 / 4545	0033250
3050 / 3055 / 3550 / 3555	0033260
3060 / 3065 / 3560 / 3565	0033270
4050 / 4055 / 4550 / 4555	0033280
5050 / 5055 / 5555	0033290
3070 / 3075 / 3570 / 3575	0033300
4060 / 4065 / 4560 / 4565	0033310
3080 / 3085 / 3580 / 3585	0033320
4070 / 4075 / 4570 / 4575	0033330
5060 / 5065 / 5560 / 5565	0033340
6060 / 6065 / 6565	0033350
3090 / 3095 / 3590 / 3595	0033360
4080 / 4085 / 4580 / 4585	0033370
5070 / 5075 / 5570 / 5575	0033380
4090 / 4095 / 4590 / 4595	0033390
5080 / 5085 / 5580 / 5585	0033400
6070 / 6075 / 6570 / 6575	0033410

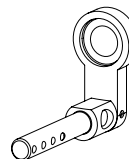

Kit 5 pcs. connecting bar for single cylinder.

3010 / 3510	0033450
4010 / 4510	0033460
5010 / 5510	0033470
6010 / 6510	0033480
7010 / 7510	0033490
8010 / 8510	0033500
9010 / 9510	0033510

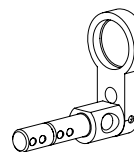

Kit 5 pcs. connecting bar for single cylinder.  
removable external control

3510	0033936
4010	0033937
4510	0033938
5010	0033939
5510	0033940
6010	0033941
6510	0033942
7010	0033943
7510	0033944
8010	0033945
8510	0033946
9010	0033947

# Libra LE60 2.1

## Accessories

### MODULAR LIBRA ASSEMBLED COMPONENTS

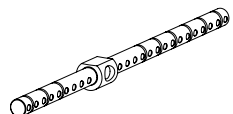

Universal connecting bar for standard version (8MK10*/8MK20* / 8MK18*/8MK28*/8MK1C*/8MK2C*)	
Kit 2 pcs. 30÷60/30÷90	0033520
Kit 2 pcs. 30÷80/30÷180	0033552
Kit 2 pcs. 30÷130/30÷130	0033553

Universal connecting bar for special version	
Kit 2 pcs. side with special function 35÷85 / 30÷90 standard side	0033935
Kit 2 pcs. side with special function 40÷90 / 30÷90 standard side	0033934

can only be cut every 10 mm

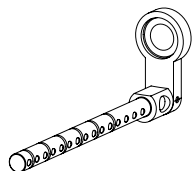

Universal connecting bar, single profile cylinder (image given for illustrative purposes only).	
Kit 2 pcs. 30÷90/10 stainless steel	0033530
Kit 2 pcs. 95÷180/10 stainless steel	0033551

Connecting bar 0033551 is drilled from 95 mm

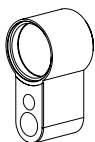

Extension for cylinder body.	
Kit 5 pcs. body extension 5 mm	0033922
Kit 5 pcs. body extension 10 mm	0033923
Kit 5 pcs. body extension 15 mm	0033924
Kit 5 pcs. body extension 20 mm	0033925
Kit 5 pcs. body extension 40 mm	0033926



Extension for cylinder body.	
Kit 5 pcs. body extension 5 mm	0033911
Kit 5 pcs. body extension 10 mm	0033912
Kit 5 pcs. body extension 15 mm	0033913
Kit 5 pcs. body extension 20 mm	0033914
Kit 5 pcs. body extension 40 mm	0033915
Kit 5 pcs. body extension 80 mm	0033916

## Libra LE60 2.1

### Accessories

### MODULAR LIBRA ASSEMBLED COMPONENTS

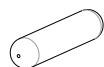

Kit 100 pcs. steel fixing pins

0033740



Kit 100 pcs. connecting ring

0033917



Kit 100 pcs. 2 Set caps electronic modular cylinder Libra body

0033919



Kit 10 pcs. Cam plug for the cylinder Libra Modular mono

0033927



Kit 10 pcs. Cam. 0° for knob modular cylinder Libra stainless steel

0033918

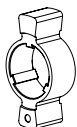

1 pcs Cam BIFFAR modular cylinder Libra stainless steel

1

0033933

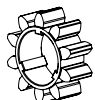

Cogwheel Z= 10 7,8 mm modular for cylinder Libra stainless steel

1

0033929

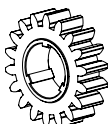

Cogwheel Z= 18 7,8 mm modular for cylinder Libra stainless steel

1

0033928

## Libra LE60 2.1

### Accessories

#### ELECTRONIC KNOB SPARE PARTS

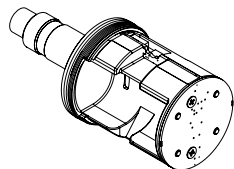

Libra LE60 Rotors, without cover, without battery.

External rotor Libra Standard	1	0033963
External rotor Heavy Duty	1	0033964
Internal rotor Libra Double	1	0033965

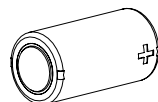

**BATTERY (compatible only with Libra LE60)**

Lithium battery FDK CR17335EF 3V 1400 mAh	1	0033960
---	---	---------

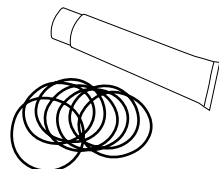

**GASKET AND GREASE COVER REPLACEMENT KIT**

Recommended to replace the cover gasket at each battery replacement (mandatory for HD version to guarantee IP66 protection degree)

Package: 20 gaskets, 1 grease tube	1	003316
------------------------------------	---	--------

## Libra LE60 2.1

### Accessories

#### “PREMIUM” KNOB COVER (RFID AND MECHANICAL VERSIONS)

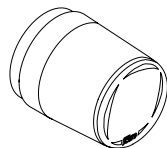

##### “PREMIUM” KNOB COVER

Suitable both for RFID reader knob and “Premium” mechanical knob.

Inox - Black	2	0444325
Inox - Metal Grey	2	0444323
Polished brass - Black	2	04443L5
Polished Chrome - White	2	04443K4
Kit 5 pcs Inox - Black	1	0444425
Kit 5 pcs Inox - Metal Grey	1	0444423
Kit 5 pcs Polished brass - Black	1	04444L5
Kit 5 pcs Polished Chrome - White	1	04444K4

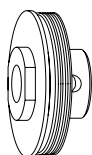

##### ADAPTER FOR MECHANICAL PREMIUM KNOB

It allows the usage of the Premium covers as mechanical inside knobs.

Package: 1 adaptor, 1 fixing screw.

	10	044240
Kit 5 pcs	1	044420

#### “STANDARD” MECHANICAL KNOB

##### “STANDARD” MECHANICAL KNOB

Internal mechanical knob.

Packaging: 1 knob, 1 battery, fixing screw.

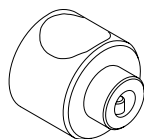

Inox	10	044232
Polished Chrome	10	04423K
Polished Brass	10	04423L
Kit 5 pcs Inox	1	044322
Kit 5 pcs Polished Chrome	1	04432K
Kit 5 pcs Polished Brass	1	04432L



## Libra LE60 2.1

### Accessories

#### ANTI-INTRUSION ACCESSORIES

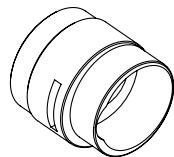

##### ANTI-INTRUSION PROTECTION KIT

For Libra cylinder, for armoured doors.

PVD polished brass	1	04425L
Satin inox	1	044252

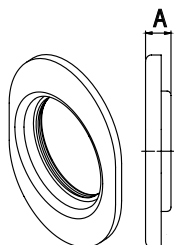

##### ANTI-INTRUSION ESCUTCHEON KIT

For Libra cylinder, for armoured doors.

A= 13 mm, PVD polished brass	1	04426L
A= 13 mm, satin inox	1	044262
A= 17 mm, PVD polished brass	1	04427L
A= 17 mm, satin inox	1	044272

## Libra LE60 2.1

### Accessories

### ASSEMBLY/DISASSEMBLY TOOLING KIT

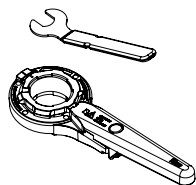

ASSEMBLY/DISASSEMBLY TOOLING KIT FOR ELECTRONIC KNOB COVER  
 Necessary for battery replacement.  
 New design with improved performances and auto assembly force detection.  
 NOT suitable for backset <45 mm.  
 Package: 1 wrench, 1 plier, instruction sheet  
 PLEASE NOTE: tool set not included with the Libra LE60. To order separately.

1 003302

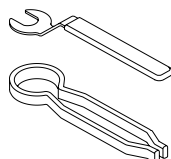

ASSEMBLY/DISASSEMBLY TOOLING KIT FOR ELECTRONIC KNOB COVER  
 Necessary for battery replacement.  
 Also suitable for backset <45 mm.  
 Package: 1 wrench, 1 plier, instruction sheet  
 PLEASE NOTE: tool set not included with the Libra LE60. To order separately.

1 003092

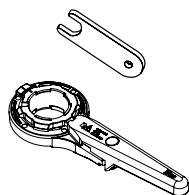

ASSEMBLY/DISASSEMBLY TOOLING KIT FOR ELECTRONIC KNOB COVER  
 installed with anti-intrusion PROTECTION kit.  
 Necessary for battery replacement.  
 New design with improved performances and auto assembly force detection.  
 Not suitable for backset <45 mm.  
 Package: 1 wrench, 1 plier, instruction sheet.  
 PLEASE NOTE: tool set not included with the Libra LE60. To order separately.

For code 04425L - 044252 1 003317

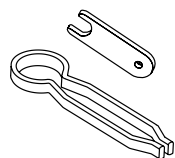

ASSEMBLY/DISASSEMBLY TOOLING KIT FOR ELECTRONIC KNOB COVER  
 installed with burglary protection ring.  
 Necessary for battery replacement  
 Also suitable for backset <45 mm.  
 Package: 1 wrench, 1 plier, instruction sheet.  
 PLEASE NOTE: tool set not included with the Libra LE60. To order separately.

For code 04425L - 044252 1 003301

## Libra LE60 2.1

### Accessories

### ASSEMBLY TOOLING KIT FOR MODULAR CYLINDERS

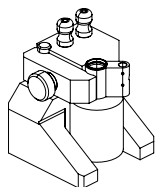

#### INSTALLATION TOOL FOR MODULAR CYLINDER LE60

Tool necessary for the assembly of modular cylinders.

Package: installation tool, 2 blocking pins

NOTE: the cylinders are supplied WITHOUT this tool. ORDER SEPARATELY.

1 0033097

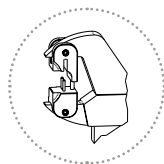

Pin driver tool on modular cylinder clamp

1 0033094

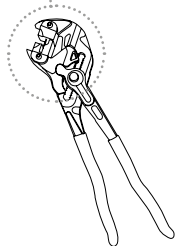

## Libra LE60 2.1

### Accessories

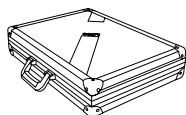

### PACKAGING DESIGN

Demo Case for Libra LE60 Smart electronic modular cylinder  
(image given for illustrative purposes only). 0033962

### ASSEMBLY CASE CONTENT

Libra LE60 cylinders assembled  
Libra LE60 Smart - Electronic modular cylinder,  
Electronic/Mechanic standard 30-30 8MK2830302562

Libra LE60 Smart - Electronic modular cylinder,  
Electronic/Mechanic removable external knob 30-50 8MK483050K462

5 pz demo card ARGO DESFIRE EV2 2K ISEO logo 5E40530K.5

Pin driver tool on modular cylinder clamp 0033094

Assembly/disassembly tooling kit for electronic knob cover 003092

Lythium battery FDK CR17335EF 3V 1400 mAh 0033960

Extension for cylinder body for Libra LE60 modular electronic cylinder.

3 pcs. body extension 5 mm L=35 0033922

3 pcs. body extension 10 mm L=40 0033923

3 pcs. body extension 15 mm L=45 0033924

3 pcs. body extension 20 mm L=50 0033925

3 pcs. body extension 40 mm L=70 0033926

1 pcs universal bar, drilled, L=85 double profile cylinder (kit da 1 pz) 0033270

1 pcs universal bar, drilled, L=105 double profile cylinder (kit da 1 pz) 0033320

1 pcs universal bar, drilled, single profile cylinder, 35/10 (kit da 1 pz) 0033936

1 pcs universal bar, drilled, single profile cylinder, 50/10 (kit da 1 pz) 0033939

Plug extension.

3 pcs. plug extension 5 mm 0033911

3 pcs. plug extension 10 mm 0033912

3 pcs. plug extension 15 mm 0033913

3 pcs. plug extension 20 mm 0033914

3 pcs. plug extension 40 mm 0033915

3 pcs. plug extension 80 mm 0033916

100 pcs. steel fixing pins 0033740

100 pcs. connecting ring, inox, mod. D15 0033917

10 pcs. cam DIN 0° 0033918

# Relay 2.0

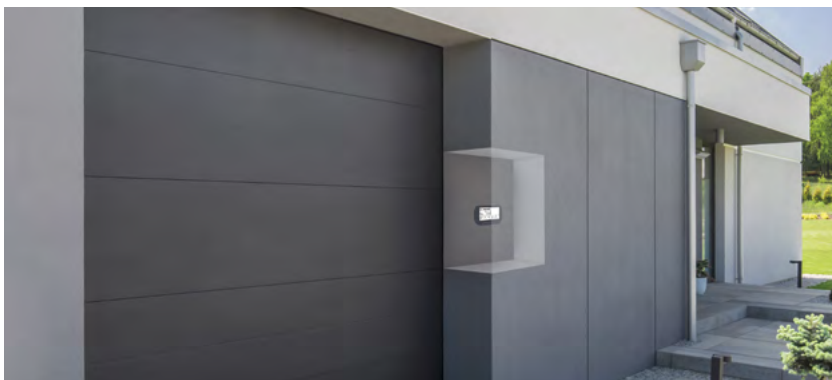

## Make your access points smart

Relay allows to open electric locks, motorized gate or any electrical actuator which can be activated closing a contact.

## Concealed installation

Relay device can have an integrated or external Bluetooth® antenna, in order to install the device even in unconventional installation spaces: the antenna can be installed in another point and connected to the device.

## Product features

- Allows to open electric locks, motorized gate or any electrical actuator which can be activated closing a contact.
- REX (REquest to eXit) is an Opto-insulated input to open the relay with a button distant up to 100 meters.
- The OUTPUT relay is a signal relay (1A) and can be also configured as NO (default) or NC by a jumper under the cover enclosure. It can be configured for different functions.
- Real Time Clock/Calendar
- Software upgradeable on-site via Bluetooth® phone (Stand Alone)

Go to page

### MODELS

- Built in Bluetooth® p. 79
- External Bluetooth® (max 3 meters) p. 80

#### ENVIRONMENTAL FEATURES

- H.R. 95% max senza condensa

#### ACCESS CREDENTIALS

- Smartphone

#### COMMUNICATION INTERFACE

- Bluetooth® Low Energy 5.1

# Relay 2.0

## Selection guide

Relay controls electric locks, motorised gates or any electrical actuator that can be activated by closing a contact. The Relay closes a contact if a smartphone has been registered on the device. Smart Relay is available in two versions, which adapt to different installation requirements.

### ORDER THE PRODUCT IN A FEW STEPS

1

Choose the appropriate template for your application and click in the column on the right :

#### Relay with integrated Bluetooth® antenna

Device used for installations where there are no range problems of the Bluetooth signal (approx. 10 m between smartphone and Relay).

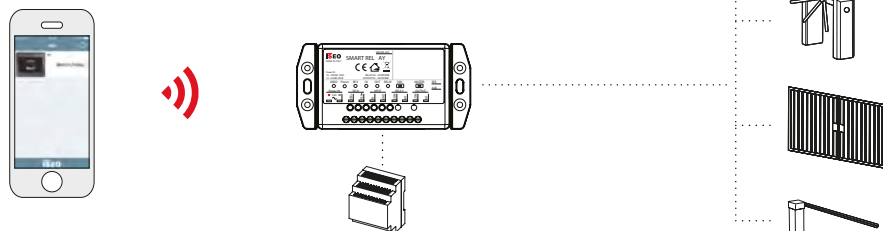

#### Relay with external Bluetooth® antenna

To be used in case it is necessary to remote the Bluetooth antenna from the installation of the Relay. The length of the cable supplied for the external antenna is 3 m.

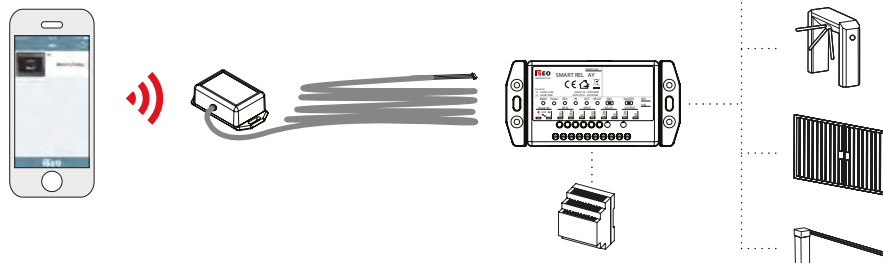

Go to page

### SELECTION GUIDE

#### MODELS

- Built in Bluetooth® p. 79
- External Bluetooth® (max 3 meters) p. 80

## V364 **Relay 2.0** Built in Bluetooth®

---

### CONNECTED ACTUATOR WITH BUILT IN Bluetooth®

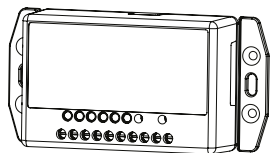

### Technical features

**FIRMWARE**  
1RIS

**RELEASE**  
2.0

**POWER UNIT**  
10÷30 Vdc (2W)  
12÷24 Vac (4VA)

#### HARDWARE SPECIFICATIONS

- 2 INPUTS: REX (Request to Exit = opening command) and configurable INPUT
- 2 OUTPUTS: RELAY 5 A and Signal Relay 1 A Configurable

#### MOUNTING

- Wall mounted
- DIN Rail 35 mounted

**WORKING TEMPERATURE**  
-25°C ÷ +70°C

**STORAGE TEMPERATURE**  
-25°C ÷ +70°C

#### PACKAGE

1 Relay, 1 Plastic pin to setup Programming Mode, 1 DIN rail mounting clip with screws, 1 Installation guide (EN/IT)

---

cod. **5E066501**

---

#### DIMENSIONS

- Width: 109mm
- Height: 53mm
- Thickness: 26mm

#### ONLINE CONTENT

---

 [Web page](#)

 [Data sheet](#)

 [Installation guide](#)

## V364 **Relay 2.0** External Bluetooth® (max 3 meters)

### CONNECTED ACTUATOR WITH EXTERNAL Bluetooth®

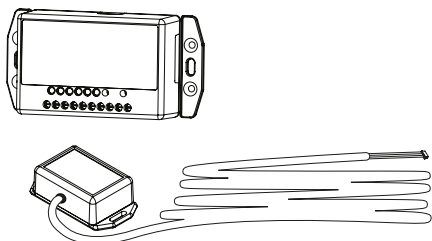

### Technical features

**FIRMWARE**  
1RIS

**RELEASE**  
2.0

**POWER UNIT**  
10÷30 Vdc (2W)  
12÷24 Vac (4VA)

#### HARDWARE SPECIFICATIONS

- 2 INPUTS: REX (Request to Exit = opening command) and configurable INPUT
- 2 OUTPUTS: RELAY 5 A and Signal Relay 1 A Configurable

#### MOUNTING

- Wall mounted
- DIN Rail 35 mounted

**WORKING TEMPERATURE**  
-25°C ÷ +70°C

**STORAGE TEMPERATURE**  
-25°C ÷ +70°C

#### PACKAGE

1 Relay, 1 Plastic pin to setup Programming Mode, 1 DIN rail mounting clip with screws, 1 Bluetooth® remote module with 3 meters cable, 1 Installation guide (EN/IT)

cod. **5E065502**

#### DIMENSIONS



Smart Relay's dimensions:

- Width: 109mm
- Height: 53mm
- Depth: 26 mm

Bluetooth® Antenna's dimensions:

- Width: 65mm
- Height: 35mm
- Depth: 15mm

#### ONLINE CONTENT

-  [Web page](#)
-  [Data sheet](#)
-  [Installation guide](#)



## Other devices

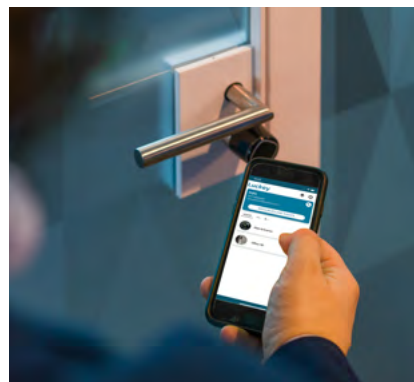

### Increases the capabilities of the Luckey system by Sofia, part of ISEO

ISEO offers an advanced range of devices that, when integrated with the access control system, create tailored solutions for the real estate sector and buildings with shared spaces. These devices expand the functionalities of Sofia's Luckey system, allowing, for example, real-time monitoring of resources such as meeting rooms. Thanks to smartphone connectivity, users can efficiently and securely manage access, bringing a new dimension to the use of shared spaces. The synergy between ISEO's access control devices and environmental management solutions creates an integrated ecosystem, optimizing the security and usability of buildings, meeting the needs of modern real estate.

Go to page

#### MODELS

- Touch Panels Hyper  
Touch Panel 10" Bluetooth® p. 82
- Sensors Hypersensor-DS  
Bluetooth® p. 83
- Tags NFC+QR HyperTag p. 84
- Desk USB2 Desk RFID UID  
Reader Mifare p. 85

## Sofia Touch Panels Hyper Touch Panel 10" Bluetooth®

### 10 INCH TOUCH PANEL WITH Bluetooth® FOR MANAGING AND CONTROLLING ROOM ACCESS FUNCTIONS



### Technical features

#### FIRMWARE

SOFIA

#### POWER UNIT

AC Input 100-240V AC 50-60Hz

#### HARDWARE SPECIFICATIONS

- Standard Webcam: 8MP, Max Resolution: 1920x1080
- Speaker: Standard: 2x 0.8W - Value: 2x 2W
- Audio Standard: 2x built-in Digital Microphones - Value: 1x built-in Analog Microphone
- 8GB SD Card SDCIT/8GBSP
- Ports: 1x USB 3.0 support (900mA), Type C USB output, Micro SD slot, GPIO, Ethernet 1x LAN (Gigabit), DC in.

#### ALERTS

- Led 3-colour series green, red, blue

#### PRODUCT COMPATIBILITY

- Bluetooth 5.0
- AES 256 bits encryption
- Indoor coverage: approx. 10m\*
- \*The total distance of Bluetooth® transmission may vary depending on the location of HyperGate Pro and the surrounding environment. For example, walls, doors, glass surfaces can reduce or interrupt communication between Smart Locks and HyperGate Pro.

#### MOUNTING

- Wall mounted

#### WORKING TEMPERATURE

0°C ÷ +40°C

#### STORAGE TEMPERATURE

-20°C ÷ +50°C

#### PACKAGE

- 1 Touch panel
- 1 Power Supply AC input voltage: 100-240 VAC;
- Input frequency: 50-60Hz

cod. 004S106

#### DIMENSIONS

Width: 252.9 mm  
Height: 169.0 mm  
Depth: 22.1 mm

Weight  
0.8 kg

#### ONLINE CONTENT

 [Web page](#)

 [Data sheet](#)

## Sofia Sensors Hypersensor-DS Bluetooth®

DOOR STATUS SENSOR (INTEGRATED INTO HYPERGATE) FOR MONITORING DOORS, WINDOWS OR ANY OTHER OBJECT YOU WANT TO MONITOR IN TERMS OF OPENING OR CLOSING



### Technical features

**FIRMWARE**  
SOFIA

**POWER UNIT**  
1 CR2032 type 3V lithium battery

**HARDWARE SPECIFICATIONS**

- Receiver sensitivity: -97 dBm @1Mbps, 0.1% BER
- Maximum transmit power +4dBm
- Indoor range: Average 10m\*
- \* Bluetooth® transmission total distance may vary depending on HyperSensor location and surrounding environment.

**MOUNTING**

- Wall mounted
- On door

**ENVIRONMENTAL FEATURES**  
- IP67

**WORKING TEMPERATURE**  
-20°C ÷ +60°C

**PACKAGE**  
1 sensor  
1 magnet

cod. 004S108

#### DIMENSIONS

Sensor Dimensions:  
3.8cm x 3.8cm x 0.9cm  
Separate Magnet Dimensions:  
2.5cm x 0.8cm x 0.7 cm

Weight  
12 g

#### ONLINE CONTENT

- Web page
- Data sheet

## Sofia Tags NFC+QR HyperTag

---

TAG FOR OPENING WITH NFC AND QR CODE ON EVERY TYPE OF LOCK AND DOOR



### Technical features

**FIRMWARE**  
SOFIA

**HARDWARE SPECIFICATIONS**  
- NXP NTAG213 ISO/IEC 14443-A Type 2  
- Communication rate: 106 kbit/s  
- 1 central hole for M3 screws

**PRODUCT COMPATIBILITY**  
- HyperTag can be applied with different fixing methods:  
- 3M adhesive (optional)  
- fixed with M3 screw  
- fixed with cable tie (maximum width 3mm)

**ENVIRONMENTAL FEATURES**  
- IP68

**WORKING TEMPERATURE**  
-35°C ÷ +85°C

**STORAGE TEMPERATURE**  
-35°C ÷ +85°C

**PACKAGE**  
1 Tag

---

cod. 004S101

---

**DIMENSIONS**  
Height: 27mm  
Width: 27mm  
Thickness: 5.5mm

Weight  
4,3 g

### ONLINE CONTENT

---

 [Web page](#)

 [Data sheet](#)

## Sofia Desk USB2 Desk RFID UID Reader Mifare

### CONTACTLESS UID READER OF RFID CARDS OR NFC TAGS

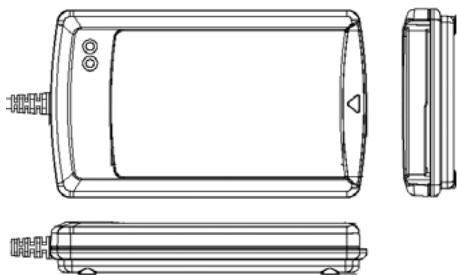

### Technical features

#### FIRMWARE

SOFIA

#### HARDWARE SPECIFICATIONS

- USB 2.0 Full Speed Interface
- USB HID Keyboard Class Emulation
- Operating Frequency 13.56 Mhz
- Read speed up to 848 kbps
- Read distance up to 50 mm (depending on Tag's antenna)

#### ALERTS

- LEDs: 1 Green, 1 Red
- Multi-frequency buzzer

#### PRODUCT COMPATIBILITY

- Compatible with ISEO CONNECTED locks when connected to Sofia Luckey.
- Compatible with operating systems: Windows®, Mac OS®, Linux, Android™

#### MOUNTING

- Desktop

#### ENVIRONMENTAL FEATURES

- H.R. 90% max

#### WORKING TEMPERATURE

0°C ÷ +50°C

#### PACKAGE

1 Reader, instruction sheet

cod. 004S107

#### DIMENSIONS

120.5 x 72 x 20.4 mm

#### Weight

140 g

#### ONLINE CONTENT

 Data sheet

Search by device

## **F9000 mechatronic keys, cylinders and padlocks**

Complementary mechanical products

# F9000 Cylinders V3



## A flexible and safe solution to protect your environments

F9000 combines the high security of mechanics with the flexibility of electronics. F9000 V3 cylinder offers the state of the art in terms of technology evolution and security. It embeds a new powerful micro-processor for security improvements (AES encryption ready) and it's ready for new market needs and features (future proof).

## Access all gates with a single key

F9000 mechatronic cylinder has the same installation and easy maintenance features as a mechanical one because it doesn't require any wiring or batteries in the cylinder. It is the ideal solution for the control of gates in any private and public building and for the management of common areas and entrances (from the single room to the building).

## Product's functions

- Each key has customized access right which can be modified at any time according to the different building management needs.
- Energy is on the key and it doesn't require any wiring.
- AES Encryption ready
- Unique non duplicable key with customized authorizations
- Fast key authentication (< 80 ms)
- Storage of opening and forcing events in the key (1000 standard events)
- Up to 120.000 keys in a single system
- Temporal validity and time slots

### FINISH

 Nickel plated

### ENVIRONMENTAL FEATURES

- IP66
- IP67
- IP68
- IP69
- Max. 93% without condensing

### ACCESS CREDENTIALS

- Mechatronic Key

### COMMUNICATION INTERFACE

- Data and energy transfer without electrical contact

### CERTIFICATIONS

- EN1303:2015 classification "16000C6D"
- EN15684:2012 classification "16B4FF32"
- Compliance with ATEX directive 2014/34/
- EU: classification "Ex II 2 G Ex ib IIB T4"

Go to page

### MODELS

- Standard p. 89
- Standard Free Cam p. 90
- Double p. 91
- Double Free Cam p. 92
- Knob p. 93
- Half p. 94
- Oval Scandinavian p. 95
- External rim nickel-plated, diam. 35 mm, U.S. type p. 96
- External rim nickel-plated, diam. 40 mm p. 97
- Round threaded nickel-plated p. 98
- Threaded nickel-plated M26, with signalling microswitch p. 99

# F9000 Cylinders V3

## Selection guide

The F9000 mechatronic cylinder has the same installation of a standard mechanical cylinder and shares the same ease of maintenance due to the absence of electrical wiring and batteries within the cylinder.

It is compatible with all mechanical cylinders in the CSF system, allowing the creation of mixed systems with varying security levels based on the importance of the access points to be controlled.

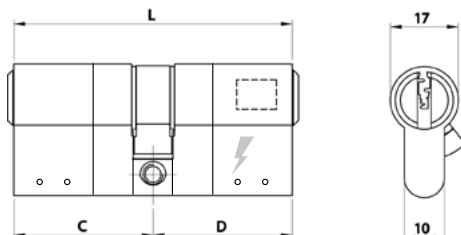

## ORDER THE PRODUCT IN A FEW STEPS

1

**Check the door type and the dimensions of the cylinder**  
(in the case of replacement on an existing door)

2

**Choose the F9000 Cylinders LE60 V3 model** in the column on the right, generating the code thanks to the configurator on the product page.

3

**Optional.**  
See accessory sheets for modifications and component replacements.

[Choose from menu](#)

[Modular F9000/F9 assembled components](#)

[Assembly tooling kit for F9000/F9 modular cylinders](#)

Go to page

### ● SELECTION GUIDE

#### MODELS

- Standard p. 89
- Standard Free Cam p. 90
- Double p. 91
- Double Free Cam p. 92
- Knob p. 93
- Half p. 94
- Oval Scandinavian p. 95
- External rim nickel-plated, diam. 35 mm, U.S. type p. 96
- External rim nickel-plated, diam. 40 mm p. 97
- Round threaded nickel-plated p. 98
- Threaded nickel-plated M26, with signalling microswitch p. 99



## F9000 Cylinders V3 Standard

MODULAR LE60 CYLINDER,  
DOUBLE NICKEL-PLATED EUROPEAN PROFILE,  
MECHATRONIC ON ONE SIDE ONLY

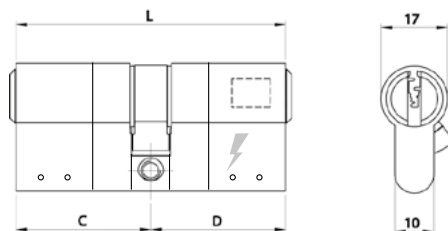
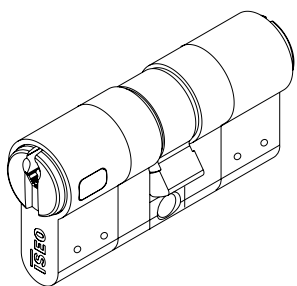

### Technical features

**FIRMWARE**  
1RIS

**RELEASE**  
V3

**POWER UNIT**  
No batteries in the cylinder, data and energy transfer from the F9000 key without electrical contact

**HARDWARE SPECIFICATIONS**

- Conventional multi-profile non-duplicable key, MK coding, 30° DIN cam. Fixing screw.
- New processor for security improvement (AES encryption ready).

**PRODUCT COMPATIBILITY**

- Compatible with Iseo CSF high security mechanical cylinders.
- The installation requires only a fixing screw just like a mechanical cylinder.
- Modular LE60 system for maximum installation flexibility.
- Compatible with all high security mechanical cylinders of the ISEO CSF series

**MOUNTING**

- It is installed like a mechanical cylinder, with a single fixing screw

**ENVIRONMENTAL FEATURES**

- IP66
- IP67
- IP68
- IP69
- Max. 93% without condensing

**WORKING TEMPERATURE**

-20°C ÷ +60°C

**STORAGE TEMPERATURE**

-25°C ÷ +70°C

**PACKAGE**

1 Mechatronic Cylinder, without keys

 Code configurator

ONLINE CONTENT

 Web page

 Specifications

 Data sheet

 Installation guide

## F9000 Cylinders V3 Standard Free Cam

MODULAR LE60 CYLINDER,  
DOUBLE NICKEL-PLATED EUROPEAN PROFILE,  
SINGLE-SIDED MECHATRONIC, FREE CAM

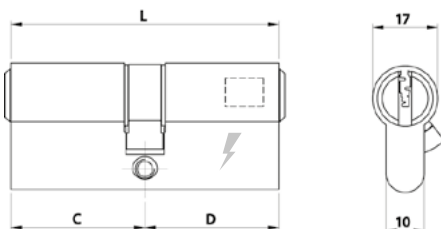
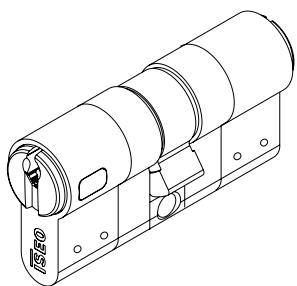

### Technical features

**FIRMWARE**  
1RIS

**RELEASE**  
V3

**POWER UNIT**  
No batteries in the cylinder, data and energy transfer from the F9000 key without electrical contact

**HARDWARE SPECIFICATIONS**

- Conventional multi-profile non-duplicable key, MK coding, 30° DIN cam. Fixing screw.
- New processor for security improvement (AES encryption ready).

**PRODUCT COMPATIBILITY**

- Compatible with Iseo CSF high security mechanical cylinders.
- The installation requires only a fixing screw just like a mechanical cylinder.
- Modular LE60 system for maximum installation flexibility.
- Compatible with all high security mechanical cylinders of the ISEO CSF series

**MOUNTING**

- It is installed like a mechanical cylinder, with a single fixing screw

**ENVIRONMENTAL FEATURES**

- IP66
- IP67
- IP68
- IP69
- Max. 93% without condensing

**WORKING TEMPERATURE**

-20°C ÷ +60°C

**STORAGE TEMPERATURE**

-25°C ÷ +70°C

**PACKAGE**

1 Mechatronic Cylinder, without keys

 Code configurator

ONLINE CONTENT

 Web page

 Specifications

 Data sheet

 Installation guide

## F9000 Cylinders V3 Double

MODULAR LE60 CYLINDER,  
DOUBLE NICKEL-PLATED EUROPEAN PROFILE,  
MECHATRONIC ON BOTH SIDES

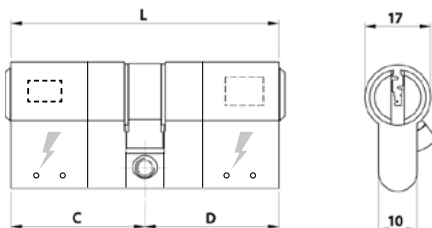
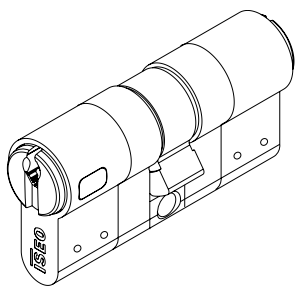

### Technical features

**FIRMWARE**  
1RIS

**RELEASE**  
V3

**POWER UNIT**  
No batteries in the cylinder, data and energy transfer from the F9000 key without electrical contact

**HARDWARE SPECIFICATIONS**

- Conventional multi-profile non-duplicable key, MK coding, 30° DIN cam. Fixing screw.
- New processor for security improvement (AES encryption ready).

**PRODUCT COMPATIBILITY**

- Compatible with Iseo CSF high security mechanical cylinders.
- The installation requires only a fixing screw just like a mechanical cylinder.
- Modular LE60 system for maximum installation flexibility.
- Compatible with all high security mechanical cylinders of the ISEO CSF series

**MOUNTING**

- It is installed like a mechanical cylinder, with a single fixing screw

**ENVIRONMENTAL FEATURES**

- IP66
- IP67
- IP68
- IP69
- Max. 93% without condensing

**WORKING TEMPERATURE**

-20°C ÷ +60°C

**STORAGE TEMPERATURE**

-20°C ÷ +70°C

**PACKAGE**

1 Mechatronic Cylinder, without keys

 Code configurator

ONLINE CONTENT

 Web page

 Specifications

 Data sheet

 Installation guide

## F9000 Cylinders V3 Double Free Cam

MODULAR LE60 CYLINDER,  
DOUBLE NICKEL-PLATED EUROPEAN PROFILE,  
MECHATRONIC ON BOTH SIDES, FREE CAM

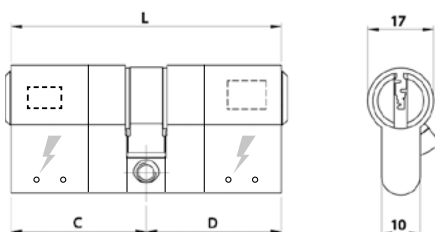
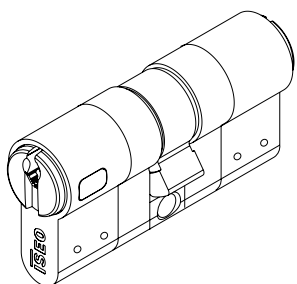

### Technical features

**FIRMWARE**  
1RIS

**RELEASE**  
V3

**POWER UNIT**  
No batteries in the cylinder, data and energy transfer from the F9000 key without electrical contact

**HARDWARE SPECIFICATIONS**

- Conventional multi-profile non-duplicable key, MK coding, 30° DIN cam. Fixing screw.
- New processor for security improvement (AES encryption ready).

**PRODUCT COMPATIBILITY**

- Compatible with Iseo CSF high security mechanical cylinders.
- The installation requires only a fixing screw just like a mechanical cylinder.
- Modular LE60 system for maximum installation flexibility.
- Compatible with all high security mechanical cylinders of the ISEO CSF series

**MOUNTING**

- It is installed like a mechanical cylinder, with a single fixing screw

**ENVIRONMENTAL FEATURES**

- IP66
- IP67
- IP68
- IP69
- Max. 93% without condensing

**WORKING TEMPERATURE**

-20°C ÷ +60°C

**STORAGE TEMPERATURE**

-20°C ÷ +70°C

**PACKAGE**

1 Mechatronic Cylinder, without keys

 Code configurator

ONLINE CONTENT

 Web page

 Specifications

 Data sheet

 Installation guide

## F9000 Cylinders V3 Knob

MODULAR LE60 CYLINDER,  
DOUBLE NICKEL-PLATED EUROPEAN PROFILE,  
MECHATRONIC ON ONE SIDE ONLY,  
ROUND KNOB ON THE MECHANICAL SIDE

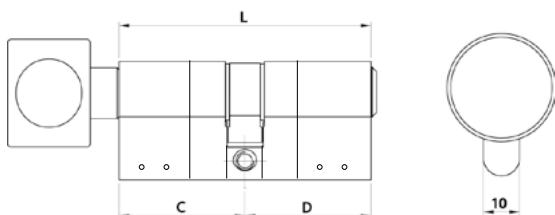
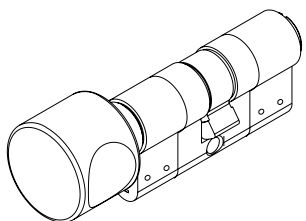

### Technical features

**FIRMWARE**  
1RIS

**RELEASE**  
V3

**POWER UNIT**  
No batteries in the cylinder, data and energy transfer from the F9000 key without electrical contact

**HARDWARE SPECIFICATIONS**

- Conventional multi-profile non-duplicable key, MK coding, 30° DIN cam. Fixing screw.
- New processor for security improvement (AES encryption ready).

**PRODUCT COMPATIBILITY**

- Compatible with Iseo CSF high security mechanical cylinders.
- The installation requires only a fixing screw just like a mechanical cylinder.
- Modular LE60 system for maximum installation flexibility.
- Compatible with all high security mechanical cylinders of the ISEO CSF series

**MOUNTING**  
- It is installed like a mechanical cylinder, with a single fixing screw

**ENVIRONMENTAL FEATURES**

- IP66
- IP67
- IP68
- IP69
- Max. 93% without condensing

**WORKING TEMPERATURE**  
-20°C ÷ +60°C

**STORAGE TEMPERATURE**  
-20°C ÷ +70°C

**PACKAGE**  
1 Mechatronic Cylinder, without keys

 Code configurator

### ONLINE CONTENT

 Web page

 Specifications

 Data sheet

 Installation guide

## F9000 Cylinders V3 Half

### MODULAR LE60 CYLINDER, MECHATRONIC NICKEL-PLATED EUROPEAN MONOPROFILE

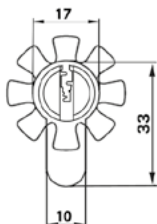
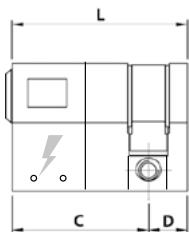
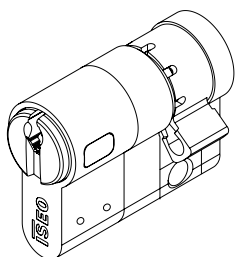

### Technical features

#### FIRMWARE

1RIS

#### RELEASE

V3

#### POWER UNIT

No batteries in the cylinder, data and energy transfer from the F9000 key without electrical contact

#### HARDWARE SPECIFICATIONS

- Conventional multi-profile, non-duplicable key, 8-position DIN cam. Fixing screw.
- New processor for security improvement (AES encryption ready).

#### PRODUCT COMPATIBILITY

- Compatible with Iseo CSF high security mechanical cylinders.
- The installation requires only a fixing screw just like a mechanical cylinder.
- Modular LE60 system for maximum installation flexibility.
- Compatible with all high security mechanical cylinders of the ISEO CSF series

#### MOUNTING

- It is installed like a mechanical cylinder, with a single fixing screw

#### ENVIRONMENTAL FEATURES

- IP66
- IP67
- IP68
- IP69
- Max. 93% without condensing

#### WORKING TEMPERATURE

-20°C ÷ +60°C

#### STORAGE TEMPERATURE

-20°C ÷ +70°C

#### PACKAGE

1 Mechatronic Cylinder, without keys

 Code configurator

### ONLINE CONTENT

 Web page

 Specifications

 Data sheet

 Installation guide

## F9000 Cylinders V3 Oval Scandinavian

### MECHATRONIC NICKEL-PLATED SCANDINAVIAN OVAL CYLINDER

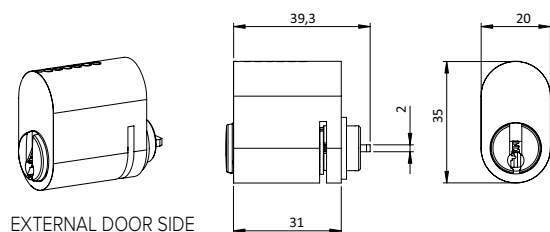

EXTERNAL DOOR SIDE

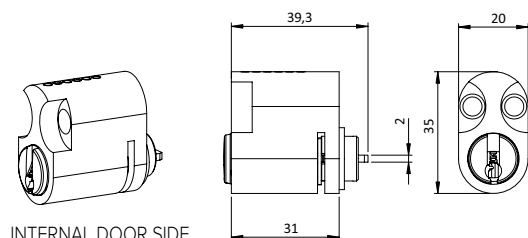

INTERNAL DOOR SIDE

### Technical features

#### FIRMWARE

1RIS

#### RELEASE

V3

#### POWER UNIT

No batteries in the cylinder, data and energy transfer from the F9000 key without electrical contact

#### HARDWARE SPECIFICATIONS

- Conventional multi-profile, non-duplicable key. MK coding.
- External and internal door side versions. Fixing screws.
- New processor for security improvement (AES encryption ready)

#### PRODUCT COMPATIBILITY

- Compatible with Iseo CSF high security mechanical cylinders.
- The installation requires only a fixing screw just like a mechanical cylinder.
- Compatible with all high security mechanical cylinders of the ISEO CSF series

#### MOUNTING

- It is installed like a mechanical cylinder, with a single fixing screw

#### ENVIRONMENTAL FEATURES

- IP66
- IP67
- IP68
- IP69
- Max. 93% without condensing

#### WORKING TEMPERATURE

-20°C ÷ +60°C

#### STORAGE TEMPERATURE

-20°C ÷ +70°C

#### PACKAGE

1 Mechatronic Cylinder, without keys

 Code configurator

### ONLINE CONTENT

 Web page

 Specifications

 Data sheet

 Installation guide

## F9000 Cylinders V3 External rim nickel-plated, diam. 35 mm, U.S. type

MECHATRONIC VERSION.  
CONVENTIONAL MULTI-PROFILE,  
NON-DUPLICABLE KEY.

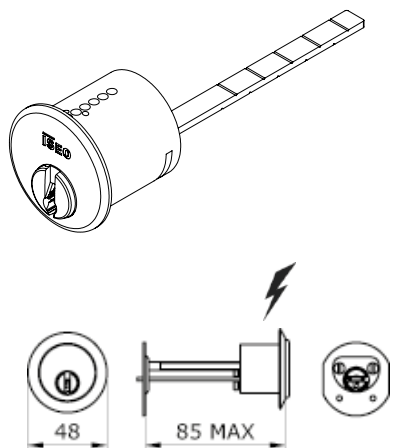

### Technical features

**FIRMWARE**  
1RIS

**RELEASE**  
V3

**POWER UNIT**  
No batteries in the cylinder, data and energy transfer from the F9000 key without electrical contact

**PRODUCT COMPATIBILITY**

- Compatible with Iseo CSF high security mechanical cylinders.
- The installation requires only a fixing screw just like a mechanical cylinder.
- To be used with rim locks without external cylinder.
- Screws for inside fixing.
- For doors max thickness mm 85

**ENVIRONMENTAL FEATURES**

- IP66
- IP67
- IP68
- IP69
- Max. 93% without condensing

**WORKING TEMPERATURE**  
-20°C ÷ +60°C

**STORAGE TEMPERATURE**  
-20°C ÷ +70°C

**PACKAGE**  
1 Mechatronic Cylinder, without keys

cod. 87VA040859M

### ONLINE CONTENT

 [Web page](#)

 [Specifications](#)

 [Data sheet](#)

 [Installation guide](#)



## F9000 Cylinders V3 External rim nickel-plated, diam. 40 mm

MECHATRONIC VERSION.  
CONVENTIONAL MULTI-PROFILE,  
NON-DUPLICABLE KEY.

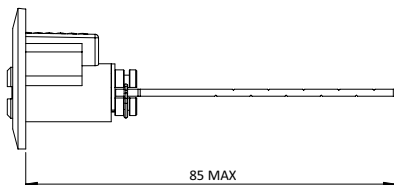
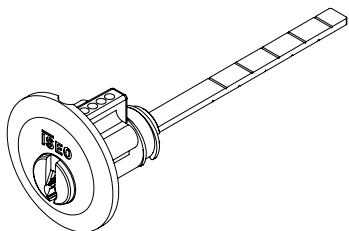

### Technical features

FIRMWARE  
1RIS

-20°C ÷ +60°C

RELEASE  
V3

STORAGE TEMPERATURE

-20°C ÷ +70°C

POWER UNIT

No batteries in the cylinder, data and energy transfer from the F9000 key without electrical contact

PACKAGE

1 Mechatronic Cylinder, without keys

PRODUCT COMPATIBILITY

- Compatible with Iseo CSF high security mechanical cylinders.
- The installation requires only a fixing screw just like a mechanical cylinder.
- To be used with rim locks without external cylinder.
- Screws for inside fixing.
- For doors max thickness mm 85

ENVIRONMENTAL FEATURES

- IP66
- IP67
- IP68
- IP69
- Max. 93% without condensing

WORKING TEMPERATURE

cod. 87VA050859M

ONLINE CONTENT

 Web page

 Specifications

 Data sheet

 Installation guide

## F9000 Cylinders V3 Round threaded nickel-plated

WITHOUT KEYS. MECHATRONIC VERSION.  
CONVENTIONAL MULTI-PROFILE,  
NON-DUPLICABLE KEY.  
SCREW NUT FOR INSIDE FIXING.

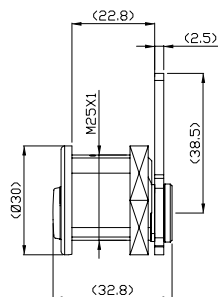
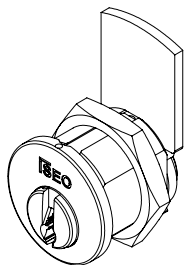

cod. 87VA23F259M

### Technical features

**FIRMWARE**  
1RIS

**WORKING TEMPERATURE**  
-20°C ÷ +60°C

**RELEASE**  
V3

**STORAGE TEMPERATURE**  
-20°C ÷ +70°C

**POWER UNIT**  
No batteries in the cylinder, data and energy transfer from the F9000 key without electrical contact

**PACKAGE**  
1 Mechatronic Cylinder, without keys

**PRODUCT COMPATIBILITY**

- Compatible with Iseo CSF high security mechanical cylinders.
- The installation requires only a fixing screw just like a mechanical cylinder.
- Screw nut for inside fixing

### ENVIRONMENTAL FEATURES

- IP66
- IP67
- IP68
- IP69
- Max. 93% without condensing

### ONLINE CONTENT

 Web page

 Specifications

 Data sheet

 Installation guide

## F9000 Cylinders V3 Threaded nickel-plated M26, with signalling microswitch

WITHOUT KEYS. MECHATRONIC VERSION.  
 CONVENTIONAL MULTI-PROFILE, NON-DUPLICABLE KEY.  
 WELDING BACK ENDS/2 mm FASTON AND NORMALLY  
 OPEN/CLOSED SWITCH DEVIATORS.  
 SCREW NUT FOR INSIDE FIXING.

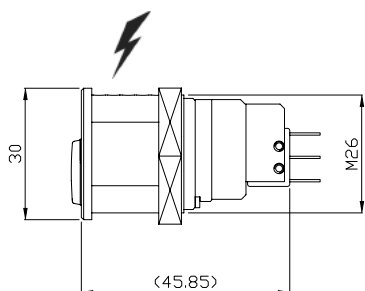
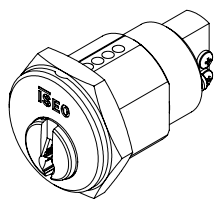

### Technical features

FIRMWARE  
1RIS

RELEASE  
V3

POWER UNIT  
No batteries in the cylinder, data and energy transfer from the F9000 key without electrical contact

PRODUCT COMPATIBILITY

- Compatible with Iseo CSF high security mechanical cylinders.
- The installation requires only a fixing screw just like a mechanical cylinder.
- Welding back ends/2 mm Faston and normally open/closed switch deviators.
- Screw nut for inside fixing.

ENVIRONMENTAL FEATURES

- IP66
- IP67
- IP68
- IP69
- Max. 93% without condensing

WORKING TEMPERATURE  
-20°C ÷ +60°C

STORAGE TEMPERATURE  
-20°C ÷ +70°C

PACKAGE  
1 Mechatronic Cylinder, without keys

cod. 87VA26M259M

### ONLINE CONTENT

 Web page

 Specifications

 Data sheet

 Installation guide

# F9 Cylinders



## Simple and robust

The vertical key-operated mechanical cylinder CSF F9, protected by a trademark, allows for the control of the distribution of blanks (available only at authorized distributors). It provides good protection against external attacks thanks to specific devices located within the cylinder. Authorized duplication is obtained upon presentation of the Property Card.

## Peace of mind with the highest level of security

The F9 cylinder, thanks to the large number of available mechanical profiles, has excellent potential for the creation of master key systems according to safety standards.

## Product features

- Cylinder body and cylinder core made of brass in the standard matte nickel-plated version.
- Suitable for installation on fire doors.
- Coding pins in stainless steel.
- Counter-pins in brass.
- Springs in stainless steel.
- Euro-profile cylinder (standard).
- Locking cam made of sintered steel.
- Locking cam in a minimum 30° position (according to DIN).
- Each cylinder contains 2 anti-picking counter-pins.
- Each cylinder has 2 profiled pins that interact with the key blade.
- Drill-resistant protection consists of a hardened steel pin in the cylinder body.
- Harmonic steel bar to increase resistance to breaking and pulling.

## CERTIFICATIONS

- DIN EN 1303: 2015-08  
(11610|B10|C16|0)

Go to page

### MODELS

- European double profile p. 102
- European double profile, free cam p. 103
- European double profile, round knob p. 104
- European single profile p. 105
- Oval Scandinavian p. 106

# F9 Cylinders

## Selection guide

The F9 cylinder, thanks to the wide range of available mechanical profiles, has excellent potential for creating master key systems according to security standards.

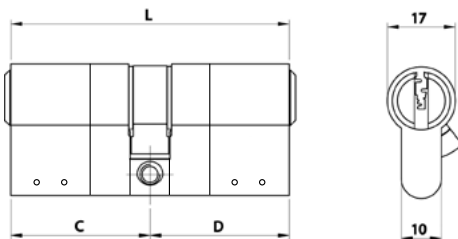

## ORDER THE PRODUCT IN A FEW STEPS

**1**

Check the door type and the dimensions of the cylinder (in the case of replacement on an existing door)

**2**

Choose the F9 Cylinders LE60 V3 model in the column on the right, generating the code thanks to the configurator on the product page.

**3**

### Optional.

See accessory sheets for modifications and component replacements.

[Choose from menu](#)

[Modular F9000/F9 assembled components](#)

[Assembly tooling kit for F9000/F9 modular cylinders](#)

Go to page

### ● SELECTION GUIDE

#### MODELS

- European double profile p. 102
- European double profile, free cam p. 103
- European double profile, round knob p. 104
- European single profile p. 105
- Oval Scandinavian p. 106

## F9 Cylinders European double profile

### MODULAR LE60 CILINDER, EUROPEAN NICKEL-PLATED DOUBLE PROFILE

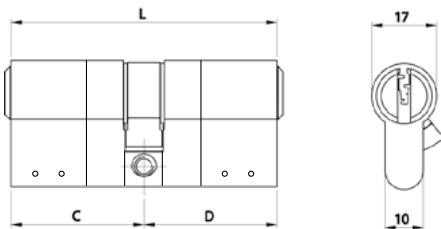
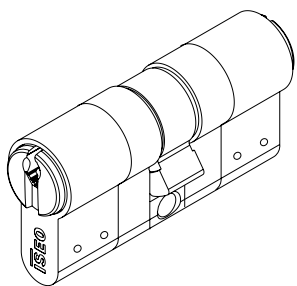

### Technical features

#### HARDWARE SPECIFICATIONS

- Mechanical version. 6-pin coding, conventional system.
- Protected key and registered profile.
- Anti-drill device in the cylinder body. STAINLESS STEEL top pins.
- 30° DIN cam. Fixing screw

#### PRODUCT COMPATIBILITY

- F9 Mechanical Key
- F9000 Mechatronic Key
- Modular LE60 system for maximum installation flexibility.

#### PACKAGE

1 cylinder, without keys

 Code configurator

 Accessories

### ONLINE CONTENT

 Web page

 User manual

 Data sheet

 Installation guide

 Leaflet

## F9 Cylinders European double profile, free cam

### MODULAR LE60 CILINDER, EUROPEAN NICKEL-PLATED DOUBLE PROFILE, FREE CAM

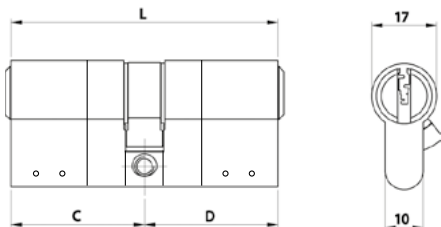
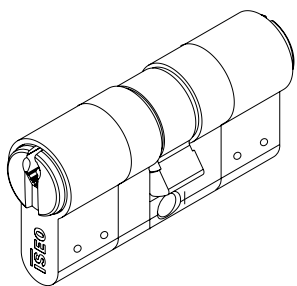

### Technical features

#### HARDWARE SPECIFICATIONS

- Mechanical version. 6-pin coding, conventional system.
- Protected key and registered profile.
- Anti-drill device in the cylinder body. STAINLESS STEEL top pins.
- 30° DIN cam. Fixing screw

#### PRODUCT COMPATIBILITY

- F9 Mechanical Key
- F9000 Mechatronic Key
- Modular LE60 system for maximum installation flexibility.

#### PACKAGE

1 cylinder, without keys

 Code configurator

 Accessories

### ONLINE CONTENT

 Web page

 User manual

 Data sheet

 Installation guide

 Leaflet

## F9 Cylinders European double profile, round knob

### MODULAR LE60 CILINDER, EUROPEAN NICKEL-PLATED DOUBLE PROFILE, ROUND KNOB

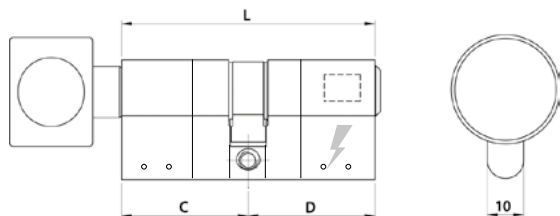
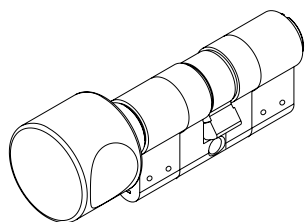

### Technical features

#### HARDWARE SPECIFICATIONS

- Mechanical version. 6-pin coding, conventional system.
- Protected key and registered profile.
- Anti-drill device in the cylinder body. STAINLESS STEEL top pins.
- 30° DIN cam. Fixing screw

#### PRODUCT COMPATIBILITY

- F9 Mechanical Key
- F9000 Mechatronic Key
- Modular LE60 system for maximum installation flexibility.

#### PACKAGE

1 cylinder, without keys

Code configurator

Accessories

### ONLINE CONTENT

Web page

User manual

Data sheet

Installation guide

Leaflet



## F9 Cylinders European single profile

### MODULAR LE60 CILINDER, EUROPEAN NICKEL-PLATED SINGLE PROFILE

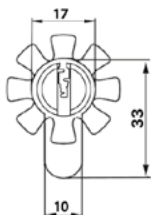
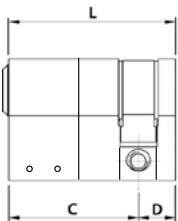
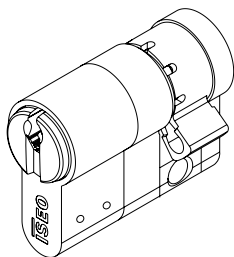

### Technical features

#### HARDWARE SPECIFICATIONS

- Mechanical version. 6-pin coding, conventional system.
- Protected key and registered profile.
- Anti-drill device in the cylinder body. STAINLESS STEEL top pins.
- 8 positions cam. Fixing screw

#### PRODUCT COMPATIBILITY

- F9 Mechanical Key
- F9000 Mechatronic Key
- Modular LE60 system for maximum installation flexibility.

#### PACKAGE

1 cylinder, without keys

 Code configurator

 Accessories

### ONLINE CONTENT

 Web page

 User manual

 Data sheet

 Installation guide

 Leaflet

## F9 Cylinders Oval Scandinavian

### OVAL SCANDINAVIAN NICKEL-PLATED CYLINDER

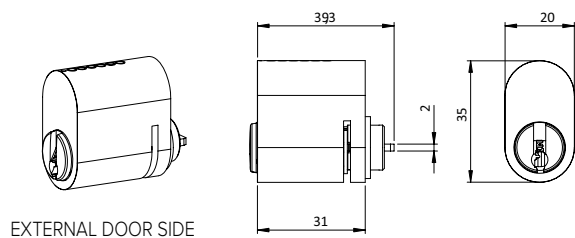

EXTERNAL DOOR SIDE

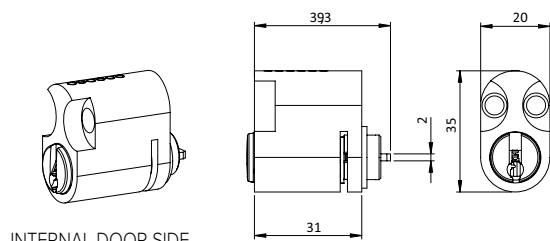

INTERNAL DOOR SIDE

### Technical features

#### HARDWARE SPECIFICATIONS

- Conventional 6-pin encryption,
- Protected key and registered profile. Anti-drill protection in the cylinder body.
- Stainless steel encryption pins.
- Version for external and internal sides of the door, fixing screws.

#### PRODUCT COMPATIBILITY

- F9 Mechanical Key
- F9000 Mechatronic Key

#### PACKAGE

1 cylinder, without keys

Code configurator

Accessories

### ONLINE CONTENT

Web page

User manual

Data sheet

Installation guide

Leaflet

## F9 Cylinders

### Accessories

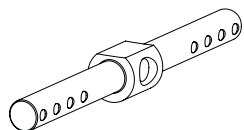

Kit 5 pcs. connecting bar for double cylinder.

3030 / 3035 / 3535	1	0033230
3040 / 3045 / 3540 / 3545	1	0033240
4040 / 4045 / 4545	1	0033250
3050 / 3055 / 3550 / 3555	1	0033260
3060 / 3065 / 3560 / 3565	1	0033270
4050 / 4055 / 4550 / 4555	1	0033280
5050 / 5055 / 5555	1	0033290
3070 / 3075 / 3570 / 3575	1	0033300
4060 / 4065 / 4560 / 4565	1	0033310
3080 / 3085 / 3580 / 3585	1	0033320
4070 / 4075 / 4570 / 4575	1	0033330
5060 / 5065 / 5560 / 5565	1	0033340
6060 / 6065 / 6565	1	0033350
3090 / 3095 / 3590 / 3595	1	0033360
4080 / 4085 / 4580 / 4585	1	0033370
5070 / 5075 / 5570 / 5575	1	0033380
4090 / 4095 / 4590 / 4595	1	0033390
5080 / 5085 / 5580 / 5585	1	0033400
6070 / 6075 / 6570 / 6575	1	0033410

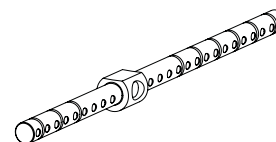

Universal connecting bar

Universal connecting bar  
in 60/90 stainless steel  
for double cylinders (2 pcs kit)

1 0033520

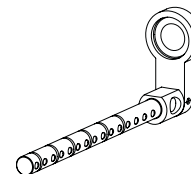

Universal connecting bar

Universal connecting bar  
in 90/10 stainless steel  
no holes for double cylinders (2 pcs kit)

1 0033530

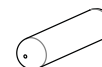

Kit 100 pcs. steel fixing pins

1 0033740

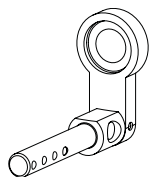

Kit 5 pcs. connecting bar for single cylinder.

3010 / 3510	1	0033450
4010 / 4510	1	0033460
5010 / 5510	1	0033470
6010 / 6510	1	0033480
7010 / 7510	1	0033490
8010 / 8510	1	0033500
9010 / 9510	1	0033510

## F9 Cylinders

### Accessories

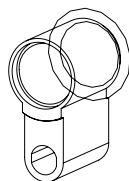

#### Extension for cylinder body.

Kit 5 pcs. body extension 5 mm	1	0033570
Kit 5 pcs. body extension 10 mm	1	0033580
Kit 5 pcs. body extension 15 mm	1	0033590
Kit 5 pcs. body extension 20 mm	1	0033600
Kit 5 pcs. body extension 40 mm	1	0033610

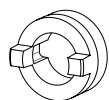

#### Plug extension

Kit 5 pcs. plug extension for double sided cylinder 35 mm	1	0033620
---	---	---------



#### Plug extension

Kit 5 pcs. plug extension for double function cylinder 35 mm	1	0033630
--	---	---------

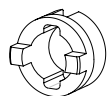

#### Plug extension

Kit 5 pcs. extension fo cylinder body for knob cylinder key side 35 mm	1	0033640
--	---	---------

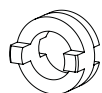

#### Plug extension

Kit 5 pcs. plug extension for knob cylinder knob side 35 mm	1	0033650
---	---	---------

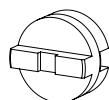

#### Plug extension

Kit 5 pcs. plug extension for single cylinder 35 mm	1	0033660
---	---	---------

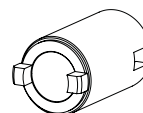

#### Plug extension

Kit 5 pcs. plug extension 10 mm	1	0033670
Kit 5 pcs. plug extension 15 mm	1	0033680
Kit 5 pcs. plug extension 20 mm	1	0033690
Kit 5 pcs. plug extension 40 mm	1	0033700

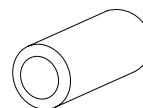

#### Key extension

Kit 10 pcs. key extension 8x5 mm	1	003211
Kit 10 pcs. key extension 8x10 mm	1	003212
Kit 10 pcs. key extension 8x15 mm	1	003213
Kit 10 pcs. key extension 8x20 mm	1	003214
Kit 10 pcs. key extension 8x25 mm	1	003215
Kit 10 pcs. key extension 8x30 mm	1	003216
Kit 10 pcs. key extension 8x35 mm	1	003217
Kit 10 pcs. key extension 8x40 mm	1	003218



250 pcs circlips	1	0033720
------------------	---	---------



Kit 50 pcs. extension pin for single cylinder F and R SERIES dim. >=40 mm	1	0033920
---	---	---------

## F9 Cylinders

---

### Accessories

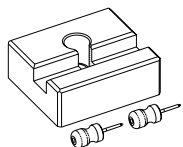

### ASSEMBLY TOOLS

Mounting base for components assembly 1 0033092

---

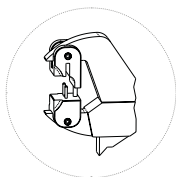

Plier for fixing pins 1 0033094

---

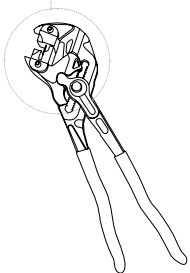

# F9000 Padlocks V3



A wide range of padlocks allowing integration in a variety of locations and use and in many different applications.

The ISEO F9000 mechatronic padlocks are meant to secure access to doors, gates, containers, hatch covers, sensitive equipment or any other application where traditional padlocks are used. Various materials are used in the padlock bodies, cylinders and shackles depending on the level of security and environmental resistance requirements. A padlock which has been equipped with a F9000 cylinder can be unlocked after identification by any matched F9000 key.

## Choose the padlock that fits for your application

ISEO offers mechatronic cylinder locks with various CEN grades, catering to a wide range of security needs. From the versatile Grade 2 for universal applications to the ultra-secure Grade 5 model, we've got you covered.

### FINISH

- Chromed
- Satin

## Product features

- Each key has customized access right which can be modified at any time according to the different building management needs.
- Energy is on the key and it doesn't require any wiring.
- Fast key authentication (< 80 ms)
- Unique non duplicable key with customized authorizations
- Storage of opening and forcing events in the key (1000 standard events)
- Up to 120.000 keys in a single system
- Temporal validity and time slots

Go to page

### MODELS

- Universal SH30 p. 112
- Universal SH50 p. 113
- Security SH25 p. 114
- Security SH50 p. 115
- Security SH60 p. 116
- Security SH110 p. 117
- High Security SH28 p. 118
- High Security SH50 p. 119
- High Security SH28 with protected shackle p. 120
- Very High Security SH27 p. 121

### ENVIRONMENTAL FEATURES

- IP66
- IP67
- IP68
- IP69
- Max. 93% without condensing

### ACCESS CREDENTIALS

- Mechatronic Key

### COMMUNICATION INTERFACE

- Data and energy transfer without electrical contact

### CERTIFICATIONS

- ATEX II 2 G Ex ib IIB T4\* for ATEX models
- EN16864: 2017 (test certificate on mechatronic padlocks)

# F9000 Padlocks V3

## Selection guide

The ISEO mechatronic padlocks are designed to provide access to doors, gates, containers, hatch closures, sensitive equipment, or any other application where mechanical padlocks are among the many available options. Various materials are used in the bodies of the padlocks, in the cylinders, and in the shackles, depending on the level of security and environmental resistance requirements.

A padlock equipped with an F9000 cylinder can be unlocked after identification any authorized F9000 key.

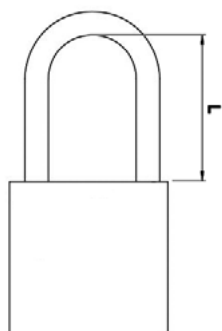

Example:

### F9000 Security SH25 Padlock

In this case, it is an F9000 GRADE 3 Padlock (medium/high security) with a shackle height of 25 mm.

## ORDER THE PRODUCT IN A FEW STEPS

1

Check the desired security level and the height of the shackle

2

Choose the F9000 padlock model in the right column

Security required	CEN Grade	ISEO padlock range
Standard security	2	Universal
Medium/High Security	3	Security
High security	4	High Security
Very High Security	5	Very High Security

Go to page

### SELECTION GUIDE

#### MODELS

- Universal SH30 p. 112
- Universal SH50 p. 113
- Security SH25 p. 114
- Security SH50 p. 115
- Security SH60 p. 116
- Security SH110 p. 117
- High Security SH28 p. 118
- High Security SH50 p. 119
- High Security SH28 with protected shackle p. 120
- Very High Security SH27 p. 121

## F9000 Padlocks V3 Universal SH30

PADLOCK WITH F9000 MECHATRONIC CYLINDER,  
SHACKLE HEIGHT 30 mm, CEN SECURITY GRADE 2



### Technical features

**FIRMWARE**  
1RIS

**WORKING TEMPERATURE**  
-20°C/+60°C.

**RELEASE**  
V3

**STORAGE TEMPERATURE**  
-20°C/+60°C.

**POWER UNIT**  
No batteries in the cylinder, data and energy transfer from the F9000 key without electrical contact

**PACKAGE**  
1 Padlock

**PRODUCT COMPATIBILITY**  
- Compatible with Iseo CSF high security mechanical cylinders.

#### ENVIRONMENTAL FEATURES

- IP66
- IP67
- IP68
- IP69
- Max. 93% without condensing

Click on the product code to download the right datasheet

Version Standard	41VA6010001130M
Version SELF-LOCKING	41VA6000001130M

 Accessories

### ONLINE CONTENT

#### DIMENSIONS

Body dimensions:  
- Width: 52 mm  
- Height: 62 mm  
- Thickness: 54 mm

Shackle dimensions:  
- Height: 30 mm  
- Width: 30 mm  
- Diameter: 8 mm



## F9000 Padlocks V3 Universal SH50

PADLOCK WITH F9000 MECHATRONIC CYLINDER,  
SHACKLE HEIGHT 50 mm, CEN SECURITY GRADE 2



### Technical features

**FIRMWARE**  
1RIS

**WORKING TEMPERATURE**  
-20°C/+60°C.

**RELEASE**  
V3

**STORAGE TEMPERATURE**  
-20°C/+60°C.

**POWER UNIT**  
No batteries in the cylinder, data and energy transfer from the F9000 key without electrical contact

**PACKAGE**  
1 Padlock

**PRODUCT COMPATIBILITY**  
- Compatible with Iseo CSF high security mechanical cylinders.

#### ENVIRONMENTAL FEATURES

- IP66
- IP67
- IP68
- IP69
- Max. 93% without condensing

Click on the product code to download the right datasheet

Version STANDARD	41VA6010001150M
Version SELF-LOCKING	41VA6000001150M

 Accessories

#### DIMENSIONS

Body dimensions:  
- Width: 52 mm  
- Height: 62 mm  
- Thickness: 54 mm

Shackle dimensions:  
- Height: 50 mm  
- Width: 30 mm  
- Diameter: 8 mm

#### ONLINE CONTENT

 Data sheet

## F9000 Padlocks V3 Security SH25

PADLOCK WITH F9000 MECHATRONIC CYLINDER,  
SHACKLE HEIGHT 25 mm, CEN SECURITY GRADE 3

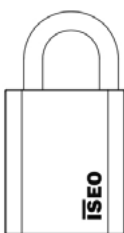

### Technical features

**FIRMWARE**  
1RIS

**WORKING TEMPERATURE**  
-20°C/+60°C.

**RELEASE**  
V3

**STORAGE TEMPERATURE**  
-20°C/+60°C.

**POWER UNIT**  
No batteries in the cylinder, data and energy transfer from the F9000 key without electrical contact

**PACKAGE**  
1 padlock

**PRODUCT COMPATIBILITY**  
- Compatible with Iseo CSF high security mechanical cylinders.

#### ENVIRONMENTAL FEATURES

- IP66
- IP67
- IP68
- IP69
- Max. 93% without condensing

Click on the product code to download the right datasheet

Version STANDARD	P3VA150252M
Version UTILITY	P3VA150252M...U
Version ATEX, UTILITY	P3VA150252MEX...U
Version SELF-LOCKING	P3VA550252M

 Accessories

#### DIMENSIONS

Body dimensions:  
- Width: 50 mm  
- Height: 62 mm  
- Thickness: 25 mm

Shackle dimensions:  
- Height: 25mm  
- Width: 24mm  
- Diameter: 8mm

#### ONLINE CONTENT

 Data sheet

## F9000 Padlocks V3 Security SH50

PADLOCK WITH F9000 MECHATRONIC CYLINDER,  
SHACKLE HEIGHT 50 mm, CEN SECURITY GRADE 3

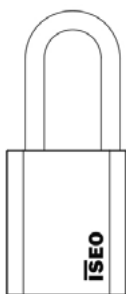

### Technical features

**FIRMWARE**  
1RIS

**RELEASE**  
V3

**POWER UNIT**  
No batteries in the cylinder, data and energy transfer from the F9000 key without electrical contact

**PRODUCT COMPATIBILITY**  
- Compatible with Iseo CSF high security mechanical cylinders.

#### ENVIRONMENTAL FEATURES

- IP66
- IP67
- IP68
- IP69
- Max. 93% without condensing

**WORKING TEMPERATURE**  
-20°C/+60°C.

**STORAGE TEMPERATURE**  
-20°C/+60°C.

**PACKAGE**  
1 Padlock

Click on the product code to download the right datasheet

Version STANDARD	P3VA150502M
Version UTILITY	P3VA150502M...U
Version ATEX, UTILITY	P3VA150502MEX...U

 Accessories

#### DIMENSIONS

Body dimensions:  
- Width: 50 mm  
- Height: 62 mm  
- Thickness: 25 mm

Shackle dimensions:  
- Height: 50 mm  
- Width: 24 mm  
- Diameter: 8 mm

#### ONLINE CONTENT

 Data sheet

## F9000 Padlocks V3 Security SH60

PADLOCK WITH F9000 MECHATRONIC CYLINDER,  
SHACKLE HEIGHT 60 mm, CEN SECURITY GRADE 3

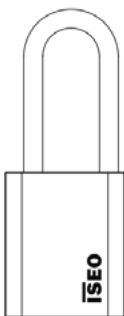

### Technical features

**FIRMWARE**  
1RIS

**RELEASE**  
V3

**POWER UNIT**  
No batteries in the cylinder, data and energy transfer from the F9000 key without electrical contact

**PRODUCT COMPATIBILITY**  
- Compatible with Iseo CSF high security mechanical cylinders.

#### ENVIRONMENTAL FEATURES

- IP66
- IP67
- IP68
- IP69
- Max. 93% without condensing

**WORKING TEMPERATURE**  
-20°C/+60°C.

**STORAGE TEMPERATURE**  
-20°C/+60°C.

**PACKAGE**  
1 Padlock

Click on the product code to download the right datasheet

Version STANDARD	P3VA150602M
Version UTILITY	P3VA150602M...U
Version ATEX, UTILITY	P3VA150602MEX...U
Version SELF-LOCKING	P3VA550602M

 Accessories

#### DIMENSIONS

Body dimensions:  
- Width: 50 mm  
- Height: 62 mm  
- Thickness: 25 mm

Shackle dimensions:  
- Height: 60 mm  
- Width: 24 mm  
- Diameter: 8 mm

#### ONLINE CONTENT

 Data sheet

## F9000 Padlocks V3 Security SH110

PADLOCK WITH F9000 MECHATRONIC CYLINDER,  
SHACKLE HEIGHT 110 mm, CEN SECURITY GRADE 3

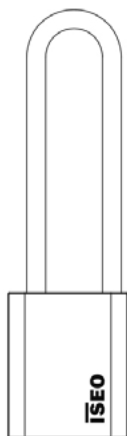

### Technical features

**FIRMWARE**  
1RIS

**WORKING TEMPERATURE**  
-20°C/+60°C.

**RELEASE**  
V3

**STORAGE TEMPERATURE**  
-20°C/+60°C.

**POWER UNIT**  
No batteries in the cylinder, data and energy transfer from the F9000 key without electrical contact

**PACKAGE**  
1 Padlock

**PRODUCT COMPATIBILITY**  
- Compatible with Iseo CSF high security mechanical cylinders.

#### ENVIRONMENTAL FEATURES

- IP66
- IP67
- IP68
- IP69
- Max. 93% without condensing

Click on the product code to download the right datasheet

Version STANDARD	P3VA1501C2M
Version UTILITY	P3VA1501C2M...U
Version ATEX, UTILITY	P3VA1501C2MEX...U

 Accessories

### ONLINE CONTENT

 Data sheet

#### DIMENSIONS

Body dimensions:  
- Width: 50 mm  
- Height: 62 mm  
- Thickness: 25 mm

Shackle dimensions:  
- Height: 110 mm  
- Width: 24 mm  
- Diameter: 8 mm

## F9000 Padlocks V3 High Security SH28

PADLOCK WITH F9000 MECHATRONIC CYLINDER,  
SHACKLE HEIGHT 28 mm, CEN SECURITY GRADE 4

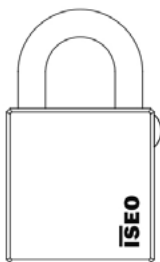

### Technical features

**FIRMWARE**  
1RIS

**WORKING TEMPERATURE**  
-20°C/+60°C.

**RELEASE**  
V3

**STORAGE TEMPERATURE**  
-20°C/+60°C.

**POWER UNIT**  
No batteries in the cylinder, data and energy transfer from the F9000 key without electrical contact

**PACKAGE**  
1 Padlock

**PRODUCT COMPATIBILITY**  
- Compatible with Iseo CSF high security mechanical cylinders.

#### ENVIRONMENTAL FEATURES

- IP66
- IP67
- IP68
- IP69
- Max. 93% without condensing

Click on the product code to download the right datasheet

Version STANDARD	P3VA160284M
Version UTILITY	P3VA160284M...U
Version ATEX, UTILITY	P3VA160284MEX...U
Version UTILITY, KEY CAP PROTECTION	P3VA16S284M...U

 Accessories

### ONLINE CONTENT

 Data sheet

#### DIMENSIONS

Body dimensions:  
- Width: 60 mm  
- Height: 62 mm  
- Thickness: 25 mm

Shackle dimensions:  
- Height: 28 mm  
- Width: 24 mm  
- Diameter: 11 mm

## F9000 Padlocks V3 High Security SH50

PADLOCK WITH F9000 MECHATRONIC CYLINDER,  
SHACKLE HEIGHT 50 mm, CEN SECURITY GRADE 4

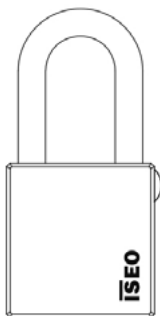

### Technical features

**FIRMWARE**  
1RIS

**WORKING TEMPERATURE**  
-20°C/+60°C.

**RELEASE**  
V3

**STORAGE TEMPERATURE**  
-20°C/+60°C.

**POWER UNIT**  
No batteries in the cylinder, data and energy transfer from the F9000 key without electrical contact

**PACKAGE**  
1 Padlock

**PRODUCT COMPATIBILITY**  
- Compatible with Iseo CSF high security mechanical cylinders.

#### ENVIRONMENTAL FEATURES

- IP66
- IP67
- IP68
- IP69
- Max. 93% without condensing

Click on the product code to download the right datasheet

Version STANDARD	P3VA160504M
Version UTILITY	P3VA160504M...U
Version ATEX, UTILITY	P3VA160504MEX...U
Version UTILITY, KEY CAP PROTECTION	P3VA16S504M...U

 Accessories

### ONLINE CONTENT

 Data sheet

#### DIMENSIONS

Body dimensions:  
- Width: 60 mm  
- Height: 62 mm  
- Thickness: 25 mm

Shackle dimensions:  
- Height: 50 mm  
- Width: 24 mm  
- Diameter: 8 mm

## F9000 Padlocks V3 High Security SH28 with protected shackle

PADLOCK WITH F9000 MECHATRONIC CYLINDER,  
SHACKLE HEIGHT 28 mm, CEN SECURITY GRADE 4,  
WITH PROTECTED SHACKLE

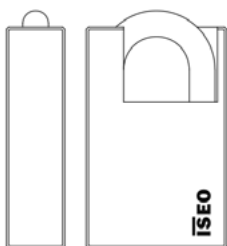

### Technical features

**FIRMWARE**  
1RIS

**WORKING TEMPERATURE**  
-20°C/+60°C.

**RELEASE**  
V3

**STORAGE TEMPERATURE**  
-20°C/+60°C.

**POWER UNIT**  
No batteries in the cylinder, data and energy transfer from the F9000 key without electrical contact

**PACKAGE**  
1 Padlock

**PRODUCT COMPATIBILITY**  
- Compatible with Iseo CSF high security mechanical cylinders.

#### ENVIRONMENTAL FEATURES

- IP66
- IP67
- IP68
- IP69
- Max. 93% without condensing

cod. P3VA260284M

 Accessories

#### DIMENSIONS

Body dimensions:

- Width: 60mm
- Height: 94 mm
- Thickness: 25 mm

Shackle dimensions:

- Height: 28 mm
- Width: 28 mm
- Diameter: 11 mm

#### ONLINE CONTENT

 Data sheet



## F9000 Padlocks V3 Very High Security SH27

PADLOCK WITH F9000 MECHATRONIC CYLINDER,  
SHACKLE HEIGHT 27 mm, CEN SECURITY GRADE 5

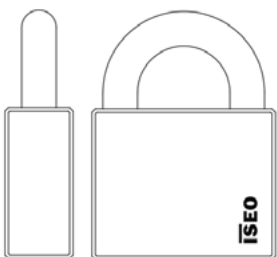

### Technical features

**FIRMWARE**  
1RIS

**WORKING TEMPERATURE**  
-20°C/+60°C.

**RELEASE**  
V3

**STORAGE TEMPERATURE**  
-20°C/+60°C.

**POWER UNIT**  
No batteries in the cylinder, data and energy transfer from the F9000 key without electrical contact

**PACKAGE**  
1 Padlock

**PRODUCT COMPATIBILITY**  
- Compatible with Iseo CSF high security mechanical cylinders.

#### ENVIRONMENTAL FEATURES

- IP66
- IP67
- IP68
- IP69
- Max. 93% without condensing

cod. **P3VA180274M**

 Accessories

#### DIMENSIONS

Body dimensions:  
- Width: 80 mm  
- Height: 65 mm  
- Thickness: 30 mm

Shackle dimensions:  
- Height: 27 mm  
- Width: 40 mm  
- Diameter: 15 mm

#### ONLINE CONTENT

 Data sheet

## F9000 Padlocks V3

---

### Accessories

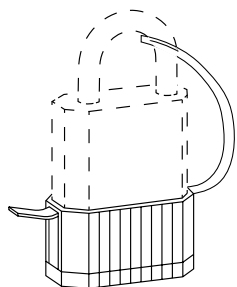

#### WEATHER PROTECTION CAP

The protective cap is made of special weather-resistant plastic which closes hermetically the body of the padlock.

Packaging: 1 black plastic cap

For ISEO F9000 Security Padlocks (Grade 3)	1	0000A00208
For ISEO F9000 High Security Padlocks (Grade 4)	1	0000A00209

# F9000 Keys



## F9000 key even more powerful thanks to Bluetooth connectivity

Equipped with a Bluetooth module and connected to the ISEO's Apps, the mechatronic key opens up an infinite range of services for the user. The mechatronic cylinders require no power source or cabling and can withstand all weather conditions. In addition to the mechanical permutation, each key is made with a unique digital identifier that cannot be changed or duplicated. In case of theft or loss, the key can be disabled in the system. Each contact between the key and a cylinder is recorded in the key's memory (cylinder, event type, date & time).

## Contactless data transfer between key and cylinder

F9000 keys hold all the system intelligence: it incorporates the power source, access control and tracking, while benefiting from the added security of its mechanical key profile. Both power transmission and data exchange between the key and the cylinder is contactless via induction, giving the system high reliability and robustness, thereby avoiding failures resulting from dirt and moisture as a result of use.

### FINISH

 Nickel plated

### MATERIAL

 Nickel silver

## Product features

- Each key has a personalized access right that can be modified at any time according to the different management needs of the building.
- Power is on the key and doesn't require any wiring.
- Fast key authentication (< 80 ms)
- Unique non duplicable key with customized authorizations
- Storage of opening and forcing events in the key (1000 standard events)

Go to page

### MODELS

- ON User Key p. 125
- ON User key with RFID transponder p. 126
- UP User Key p. 127
- UP User key with RFID transponder p. 128
- PR Programmer Key p. 129
- EM Emergency Key p. 130
- LO Lockout Key p. 131
- RL Reversal Lockout Key p. 132

### ENVIRONMENTAL FEATURES

- IP65
- Max. 93% without condensing
- Impact protection degree IK8

### COMMUNICATION INTERFACE

- Data and energy transfer without electrical contact
- Radio 2.4 GHz

### CERTIFICATIONS

- EN1303:2015 "16000C6D" classification
- EN15684:2012 "16B4FF32" classification

# F9000 Keys

## Selection guide

The electronic keys F9000 have the same features as the mechanical keys, moreover they represent the energy source for the cylinder and transfer the customized credentials for each user.

There are different types of F9000 keys, differing in technical characteristics and use cases.



## ORDER THE PRODUCT IN A FEW STEPS

1

### Check the type of key necessary in your system

reading the distinctive characteristics of each model shown on this page.

2

### Choose the F9000 key model in the right column.

#### USER KEY F9000 ON

The Radio 2.4 GHz embedded connectivity provides the possibility to remotely update and validate authorizations with smartphones at anytime and anywhere.

#### USER KEY F9000 UP

The F9000 UP can be programmed with the stationary F9000 reader/writer devices (validator).

#### PROGRAMMER KEY F9000 PR

The programmer key (PR) is used to download events from the cylinder and to re-program the cylinders. The key has radio 2.4 GHz connectivity for direct programming with the ISEO V364 smartphone. The programmer key CANNOT OPEN the cylinder: in fact, it does not have a F9000 mechanical coding.

#### EMERGENCY KEY F9000 EM

The emergency key (EM) opens all cylinders at any time in case of situations that poses an immediate risk to health, life, property or environment. This key is specifically designed to enable the fire brigade to access the facility in case of an emergency. The emergency key has the override functionality, opening double profile cylinder fitted with double function even where there is another key inserted in a lock position on the other side.

#### LOCKOUT KEY F9000 LO

In case of a terroristic attack there should be the possibility to block the access to all the access users even if they have an active F9000 key to open the door. The lockout key (LO) when is inserted into the F9000 cylinder will block all the access users and also will open the cylinder. The emergency key cannot be blocked. The lockout key works at any time. The lockout key has the override functionality opening double profile cylinder fitted with double function even where there is another key inserted in a lock position on the other side.

#### REVERSAL LOCKOUT KEY F9000 RL

The reversal lockout (RL) has characteristics similar to those of the lockout key (LO), but it will bring back the door to normal operation ("key to clear") and also will perform the open operation.

Go to page

### SELECTION GUIDE

#### MODELS

- ON User Key p. 125
- ON User key with RFID transponder p. 126
- UP User Key p. 127
- UP User key with RFID transponder p. 128
- PR Programmer Key p. 129
- EM Emergency Key p. 130
- LO Lockout Key p. 131
- RL Reversal Lockout Key p. 132

## F9000 Keys ON User Key

### F9000 USER MECHATRONIC KEY WITH RADIO 2.4 GHZ CONNECTIVITY FOR DATA UPDATING VIA SMARTPHONE



Click on the product code to download the right datasheet

Version STANDARD	<a href="#">80SAMKI030</a>
Version with ACOUSTIC SIGNALS	<a href="#">80SAMKI03Z</a>
Version ATEX	<a href="#">80SAMKI030.EX</a>
Version compatible with F900 mechanical cylinders	<a href="#">80SMMKI030</a>
Version compatible with F900 mechanical cylinders - Version ATEX	<a href="#">80SMMKI030.EX</a>

 Accessories

#### DIMENSIONS

- Paracentric key profile
- Total length: 91 mm
- Body length: 51 mm
- Body thickness: 18 mm
- Key neck 12 mm long, suitable for Defender

### Technical features

**FIRMWARE**  
1RIS

-20°C ÷ +70°C

**POWER UNIT**  
1 lithium battery CR2450

**STORAGE TEMPERATURE**  
-20°C ÷ +70°C

**ESTIMATED BATTERY LIFE**  
5 years.  
Estimated at 20 °C with 10 openings per day.

**PACKAGE**  
The pack can contain up to 10 keys

**ALERTS**  
- LEDs: 1 Green, 1 Red



**ACCESSORIES (NOT INCLUDED)**  
- Back cover for replacement in electronic keys (code E03270)  
- Back cover with RFID MIFARE Classic 4K (code E03271)  
- Back cover with RFID MIFARE Desfire EV2 8K (code E03273)  
- Lithium battery CR2450 for F9000 keys (code E03291)

**PRODUCT COMPATIBILITY**  
- Compatible with Iseo CSF high security mechanical cylinders.  
- The installation requires only a fixing screw just like a mechanical cylinder.  
- Compatible with mechanical cylinders from the same range

**ENVIRONMENTAL FEATURES**  
- IP65  
- Max. 93% without condensing  
- Impact protection degree IK8

#### WORKING TEMPERATURE

#### ONLINE CONTENT

-  Web page
-  Data sheet
-  User manual

## F9000 Keys ON User key with RFID transponder

### F9000 USER MECHATRONIC KEY WITH INTEGRATED RFID TRANSPONDER AND RADIO 2.4 GHZ CONNECTIVITY FOR DATA UPDATING VIA SMARTPHONE

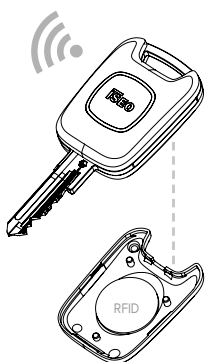

Click on the product code to download the right datasheet

Version MIFARE CLASSIC 4K, STANDARD	<a href="#">80SAMK1130</a>
Version MIFARE CLASSIC 4K, ATEX	<a href="#">80SAMK1130.EX</a>
Version MIFARE Classic 4K, compatible with F900 mechanical cylinders	<a href="#">80SMMK1130</a>
Version MIFARE Classic 4K, compatible with F900 mechanical cylinders - Version ATEX	<a href="#">80SMMK11S0.EX</a>
Version MIFARE Desfire EV2 8K, STANDARD	<a href="#">80SAMK1330</a>
Version MIFARE Desfire EV2 8K, ATEX	<a href="#">80SAMK1330.EX</a>
Version MIFARE Desfire EV2 8K, compatible with F900 mechanical cylinders	<a href="#">80SMMK1330</a>
Version MIFARE Desfire EV2 8K, compatible with F900 mechanical cylinders - Version ATEX	<a href="#">80SMMK1330.EX</a>

 Accessories

#### DIMENSIONS

- Paracentric key profile
- Total length: 91 mm
- Body length: 51 mm
- Body thickness: 18 mm
- Key neck 12 mm long, suitable for Defender

### Technical features

**FIRMWARE**  
1RIS

**POWER UNIT**  
1 lithium battery CR2450

**ESTIMATED BATTERY LIFE**  
5 years.  
Estimated at 20 °C with 10 openings per day.

**ALERTS**  
- LEDs: 1 Green, 1 Red

**PRODUCT COMPATIBILITY**  
- Compatible with Iseo CSF high security mechanical cylinders.  
- The installation requires only a fixing screw just like a mechanical cylinder.  
- Compatible with mechanical cylinders from the same range

**ENVIRONMENTAL FEATURES**  
- IP65  
- Max. 93% without condensing  
- Impact protection degree IK8



**WORKING TEMPERATURE**  
-20°C ÷ +70°C

**STORAGE TEMPERATURE**  
-20°C ÷ +70°C

**PACKAGE**  
The pack can contain up to 10 keys

**ACCESSORIES (NOT INCLUDED)**  
- Back cover for replacement in electronic keys (code E03270)  
- Back cover with RFID MIFARE Classic 4K (code E03271)  
- Back cover with RFID MIFARE Desfire EV2 8K (code E03273)  
- Lithium battery CR2450 for F9000 keys (code E03291)

### ONLINE CONTENT

-  [Web page](#)
-  [Data sheet](#)
-  [User manual](#)

## F9000 Keys UP User Key

### F9000 USER MECHATRONIC KEY



Click on the product code to download the right datasheet

Version STANDARD	<a href="#">80SAMKIOS0</a>
Version with ACOUSTIC SIGNALS	<a href="#">80SAMKIOSZ</a>
Version ATEX	<a href="#">80SAMKIOS0.EX</a>
Version compatible with F900 mechanical cylinders	<a href="#">80SMMKIOS0</a>
Version compatible with F900 mechanical cylinders - Version ATEX	<a href="#">80SMMKIOS0.EX</a>

 Accessories

#### DIMENSIONS

- Paracentric key profile
- Total length: 91 mm
- Body length: 51 mm
- Body thickness: 18 mm
- Key neck 12 mm long, suitable for Defender

### Technical features

**FIRMWARE**  
1RIS

**POWER UNIT**  
1 lithium battery CR2450

**ESTIMATED BATTERY LIFE**  
5 years.  
Estimated at 20 °C with 10 openings per day.

**ALERTS**  
- LEDs: 1 Green, 1 Red

**PRODUCT COMPATIBILITY**  
- Compatible with Iseo CSF high security mechanical cylinders.  
- The installation requires only a fixing screw just like a mechanical cylinder.  
- Compatible with mechanical cylinders from the same range

#### ENVIRONMENTAL FEATURES

- IP65
- Max. 93% without condensing
- Impact protection degree IK8

**WORKING TEMPERATURE**  
-20°C ÷ +70°C



**STORAGE TEMPERATURE**  
-20°C ÷ +70°C

**PACKAGE**  
The pack can contain up to 10 keys

#### ACCESSORIES (NOT INCLUDED)

- Back cover for replacement in electronic keys (code E03270)
- Back cover with RFID MIFARE Classic 4K (code E03271)
- Back cover with RFID MIFARE Desfire EV2 8K (code E03273)
- Lithium battery CR2450 for F9000 keys (code E03291)

#### ONLINE CONTENT

-  [Web page](#)
-  [Data sheet](#)
-  [User manual](#)

## F9000 Keys UP User key with RFID transponder

### F9000 USER MECHATRONIC KEY WITH INTEGRATED RFID TRANSPONDER

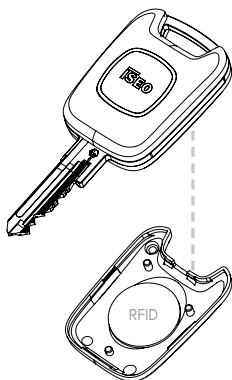

Click on the product code to download the right datasheet

Version MIFARE Classic 4K, STANDARD	<a href="#">80SAMK11S0</a>
Version MIFARE Classic 4K, ATEX	<a href="#">80SAMK11S0.EX</a>
Version MIFARE CLASSIC 4K, compatible with F900 mechanical cylinders	<a href="#">80SMMK11S0</a>
Version MIFARE CLASSIC 4K, compatible with F900 mechanical cylinders - Version ATEX	<a href="#">80SMMK11S0.EX</a>
Version MIFARE DESFIRE EV2 8K, STANDARD	<a href="#">80SAMK13S0</a>
Version MIFARE Desfire EV2 8K, ATEX	<a href="#">80SAMK13S0.EX</a>
Version MIFARE Desfire EV2 8K, compatible with F900 mechanical cylinders	<a href="#">80SMMK13S0</a>
Version MIFARE Desfire EV2 8K, compatible with F900 mechanical cylinders - Version ATEX	<a href="#">80SMMK13S0.EX</a>

 Accessories

#### DIMENSIONS

- Paracentric key profile
- Total length: 91 mm
- Body length: 51 mm
- Body thickness: 18 mm
- Key neck 12 mm long, suitable for Defender

### Technical features

**FIRMWARE**  
1RIS

**POWER UNIT**  
1 lithium battery CR2450

**ESTIMATED BATTERY LIFE**  
5 years.  
Estimated at 20 °C with 10 openings per day.

**ALERTS**  
- LEDs: 1 Green, 1 Red

**PRODUCT COMPATIBILITY**  
- Compatible with Iseo CSF high security mechanical cylinders.  
- The installation requires only a fixing screw just like a mechanical cylinder.  
- Compatible with mechanical cylinders from the same range

**ENVIRONMENTAL FEATURES**  
- IP65  
- Max. 93% without condensing  
- Impact protection degree IK8



**WORKING TEMPERATURE**  
-20°C ÷ +70°C

**STORAGE TEMPERATURE**  
-20°C ÷ +70°C

**PACKAGE**  
The pack can contain up to 10 keys

**ACCESSORIES (NOT INCLUDED)**  
- Back cover for replacement in electronic keys (code E03270)  
- Back cover with RFID MIFARE Classic 4K (code E03271)  
- Back cover with RFID MIFARE Desfire EV2 8K (code E03273)  
- Lithium battery CR2450 for F9000 keys (code E03291)

### ONLINE CONTENT

-  [Web page](#)
-  [Data sheet](#)
-  [User manual](#)



## F9000 Keys PR Programmer Key

### F9000 PROGRAMMER MECHATRONIC KEY



### Technical features

**FIRMWARE**  
1RIS

**POWER UNIT**  
1 lithium battery CR2450

**ESTIMATED BATTERY LIFE**  
5 years.  
Estimated at 20 °C with 10 openings per day.

**ALERTS**  
- LEDs: 1 Green, 1 Red

**PRODUCT COMPATIBILITY**  
- Compatible with Iseo CSF high security mechanical cylinders.  
- The installation requires only a fixing screw just like a mechanical cylinder.  
- Compatible with mechanical cylinders from the same range

**ENVIRONMENTAL FEATURES**  
- IP65  
- Max. 93% without condensing  
- Impact protection degree IK8

**WORKING TEMPERATURE**  
-20°C ÷ +70°C

**STORAGE TEMPERATURE**  
-20°C ÷ +70°C

**PACKAGE**  
The pack can contain up to 10 keys

**ACCESSORIES (NOT INCLUDED)**  
- Back cover for replacement in electronic keys (code E03270)  
- Back cover with RFID MIFARE Classic 4K (code E03271)  
- Back cover with RFID MIFARE Desfire EV2 8K (code E03273)  
- Lithium battery CR2450 for F9000 keys (code E03291)

Click on the product code to download the right datasheet



Version STANDARD	80SE001030
Version ATEX	80SE001030.EX

 Accessories

### DIMENSIONS

- Paracentric key profile
- Total length: 91 mm
- Body length: 51 mm
- Body thickness: 18 mm
- Key neck 12 mm long, suitable for Defender

### ONLINE CONTENT

-  Web page
-  Data sheet
-  User manual

## F9000 Keys EM Emergency Key

### F9000 EMERGENCY MECHATRONIC KEY



Click on the product code to download the right datasheet

Version STANDARD	<a href="#">80SAMKIPSO</a>
Version ATEX	<a href="#">80SAMKIPSO.EX</a>
Version compatible with F900 mechanical cylinders	<a href="#">80SMMKIPSO</a>
Version compatible with F900 mechanical cylinders - Version ATEX	<a href="#">80SMMKIPSO.EX</a>

 [Accessories](#)

#### DIMENSIONS

- Paracentric key profile
- Total length: 91 mm
- Body length: 51 mm
- Body thickness: 18 mm
- Key neck 12 mm long, suitable for Defender

### Technical features

**FIRMWARE**  
1RIS

**POWER UNIT**  
1 lithium battery CR2450

**ESTIMATED BATTERY LIFE**  
5 years.  
Estimated at 20 °C with 10 openings per day.

**ALERTS**  
- LEDs: 1 Green, 1 Red

**PRODUCT COMPATIBILITY**  
- Compatible with Iseo CSF high security mechanical cylinders.  
- The installation requires only a fixing screw just like a mechanical cylinder.  
- Compatible with mechanical cylinders from the same range

**ENVIRONMENTAL FEATURES**  
- IP65  
- Max. 93% without condensing  
- Impact protection degree IK8



**WORKING TEMPERATURE**  
-20°C ÷ +70°C

**STORAGE TEMPERATURE**  
-20°C ÷ +70°C

**PACKAGE**  
The pack can contain up to 10 keys

**ACCESSORIES (NOT INCLUDED)**  
- Back cover for replacement in electronic keys (code E03270)  
- Back cover with RFID MIFARE Classic 4K (code E03271)  
- Back cover with RFID MIFARE Desfire EV2 8K (code E03273)  
- Lithium battery CR2450 for F9000 keys (code E03291)

### ONLINE CONTENT

-  [Web page](#)
-  [Data sheet](#)
-  [User manual](#)

## F9000 Keys LO Lockout Key

### F9000 LOCKING MECHATRONIC KEY

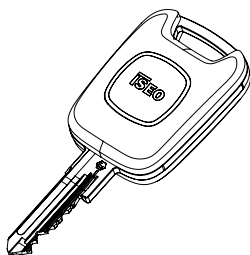

Click on the product code to download the right datasheet

Version STANDARD	<a href="#">80SAMKILSO</a>
Version ATEX	<a href="#">80SAMKILSO.EX</a>
Version compatible with F900 mechanical cylinders	<a href="#">80SMMKILSO</a>
Version compatible with F900 mechanical cylinders - Version ATEX	<a href="#">80SMMKILSO.EX</a>

 Accessories

#### DIMENSIONS

- Paracentric key profile
- Total length: 91 mm
- Body length: 51 mm
- Body thickness: 18 mm
- Key neck 12 mm long, suitable for Defender

### Technical features

**FIRMWARE**  
1RIS

**POWER UNIT**  
1 lithium battery CR2450

**ESTIMATED BATTERY LIFE**  
5 years.  
Estimated at 20 °C with 10 openings per day.

**ALERTS**  
- LEDs: 1 Green, 1 Red

**PRODUCT COMPATIBILITY**  
- Compatible with Iseo CSF high security mechanical cylinders.  
- The installation requires only a fixing screw just like a mechanical cylinder.  
- Compatible with mechanical cylinders from the same range

**ENVIRONMENTAL FEATURES**  
- IP65  
- Max. 93% without condensing  
- Impact protection degree IK8



**WORKING TEMPERATURE**  
-20°C ÷ +70°C

**STORAGE TEMPERATURE**  
-20°C ÷ +70°C

**PACKAGE**  
The pack can contain up to 10 keys

**ACCESSORIES (NOT INCLUDED)**  
- Back cover for replacement in electronic keys (code E03270)  
- Back cover with RFID MIFARE Classic 4K (code E03271)  
- Back cover with RFID MIFARE Desfire EV2 8K (code E03273)  
- Lithium battery CR2450 for F9000 keys (code E03291)

### ONLINE CONTENT

-  [Web page](#)
-  [Data sheet](#)
-  [User manual](#)

## F9000 Keys RL Reversal Lockout Key

### F9000 UNLOCKING MECHATRONIC KEY

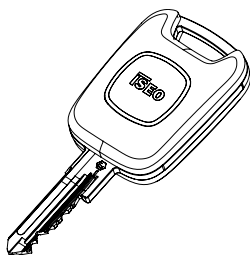

Click on the product code to download the right datasheet

Version STANDARD	<b>80SAMKIRS0</b>
Version ATEX	<b>80SAMKIRS0.EX</b>
Version compatible with F900 mechanical cylinders	<b>80SMMKIRS0</b>
Version compatible with F900 mechanical cylinders - Version ATEX	<b>80SMMKIRS0.EX</b>

 Accessories

#### DIMENSIONS

- Paracentric key profile
- Total length: 91 mm
- Body length: 51 mm
- Body thickness: 18 mm
- Key neck 12 mm long, suitable for Defender

### Technical features

**FIRMWARE**  
1RIS

**POWER UNIT**  
1 lithium battery CR2450

**ESTIMATED BATTERY LIFE**  
5 years.  
Estimated at 20 °C with 10 openings per day.

**ALERTS**  
- LEDs: 1 Green, 1 Red

**PRODUCT COMPATIBILITY**  
- Compatible with Iseo CSF high security mechanical cylinders.  
- The installation requires only a fixing screw just like a mechanical cylinder.  
- Compatible with mechanical cylinders from the same range

**ENVIRONMENTAL FEATURES**  
- IP65  
- Max. 93% without condensing  
- Impact protection degree IK8



**WORKING TEMPERATURE**  
-20°C ÷ +70°C

**STORAGE TEMPERATURE**  
-20°C ÷ +70°C

**PACKAGE**  
The pack can contain up to 10 keys

**ACCESSORIES (NOT INCLUDED)**  
- Back cover for replacement in electronic keys (code E03270)  
- Back cover with RFID MIFARE Classic 4K (code E03271)  
- Back cover with RFID MIFARE Desfire EV2 8K (code E03273)  
- Lithium battery CR2450 for F9000 keys (code E03291)

### ONLINE CONTENT

-  Web page
-  Data sheet
-  User manual

## F9000 Keys

### Accessories

#### F9000 ON, F9000 UP AND SERVICE KEYS

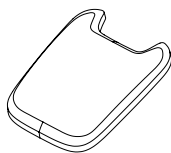

##### BACK COVER

Back cover for replacement in electronic keys (ON, UP, PR and EM)

10 E03270

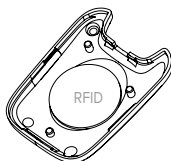

##### CBACK COVER WITH RFID TRANSPONDER KIT

Back cover for user key with integrated transponder, allowing to use key in compatible access control systems (other typologies of transponders available on request).

MIFARE Classic 4K transponder

10 E03271

MIFARE Desfire EV2 8K transponder

10 E03273

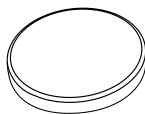

##### LITHIUM BATTERY FOR F9000 ON/UP/PR/EM KEYS

Button Battery CR2450 for replacement in electronic keys (ON, UP, PR and EM).

10 E03291

# F9000 Readers and validators

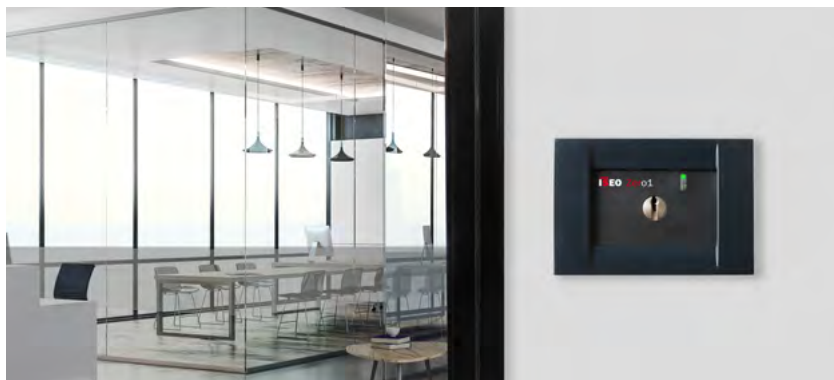

## F9000 key validators

The F9000 Readers/Writers can be connected to the ATLAS controller in order to create, validate and update the F9000 keys. Connecting an electric lock actuator it is possible to control a gate in online mode.

## Product features

- The reader/writer create, validate and update the F9000 keys

## For many applications

The Readers/Writers are available in different forms in order to answer to the installation needs of the customer: 5 versions are available for different types of installation, environmental conditions and exposure to the risk of damage and vandalism.

### MATERIAL

 Technopolymer

### COLOR

 Black

### ENVIRONMENTAL FEATURES

- IP20 / IP40 / IP55 / IP66 / IP67 / IP68
- Impact protection degree IK10
- High Corrosion Resistance: Tested for 480 hours in NSS (Neutral Salt Spray)

### ACCESS CREDENTIALS

- Mechatronic Key

### COMMUNICATION INTERFACE

- Data and energy transfer without electrical contact
- RS485

Go to page

→ **SELECTION GUIDE**

### MODELS

- Desktop validator p. 135
- Flush mounted validator p. 136
- Wall mounted validator p. 137
- IP55 Wall mounted validator with protective flap p. 138
- Heavy Duty vandal-proof validator p. 139

## F9000 Readers and validators Desktop validator

THE F9000 READER/WRITER CAN BE CONNECTED TO THE ATLAS OFFLINE SEVER IN ORDER TO CREATE, VALIDATE AND UPDATE THE F9000 KEYS

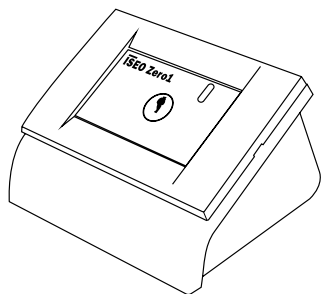

### Technical features

**FIRMWARE**  
1RIS

**POWER UNIT**  
10 -24Vdc - Powered through connection to the ATLAS server

**ALERTS**  
- Led 3-colour series green, red, blue

**PRODUCT COMPATIBILITY**  
- The F9000 Validators/Readers can be connected to the ATLAS offline sever in order to create, validate and update the F9000 keys with V2 firmware and F9000 ON/UP/EM/PR keys. Connecting an electric lock actuator it is possible to control a gate in online mode.

**MOUNTING**  
- Desktop

**WORKING TEMPERATURE**  
-10°C ÷ +50°C

**STORAGE TEMPERATURE**  
-25°C ÷ +75°C

**PACKAGE**  
1 reader/writer, 1 installation manual

**ACCESSORIES (NOT INCLUDED)**  
- Electric lock actuator (code 5E2501)

cod. E03212



### DIMENSIONS

Vimar Idea desktop plastic Box

- Width: 120 mm
- Height: 82 mm
- Depth: 111 mm

### ONLINE CONTENT

 Web page

 Data sheet

 Installation guide

 Specifications

## F9000 Readers and validators Flush mounted validator

THE F9000 READERS/WRITERS CAN BE CONNECTED TO THE ATLAS OFFLINE SEVER IN ORDER TO CREATE, VALIDATE AND UPDATE THE F9000 KEYS

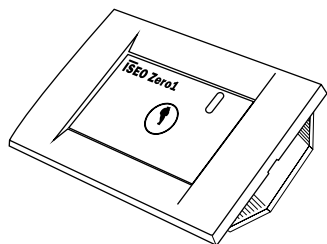

### Technical features

**FIRMWARE**  
1RIS

**POWER UNIT**  
10 -24Vdc - Powered through connection to the ATLAS server

**ALERTS**  
- Led 3-colour series green, red, blue

**PRODUCT COMPATIBILITY**  
- The F9000 readers/writers can be connected to the ATLAS offline sever in order to create, validate and update the F9000 keys with V2 firmware and F9000 ON/UP/EM/PR keys.  
Connecting an electric lock actuator it is possible to control a gate in online mode.

**MOUNTING**  
- Flush mounted

**WORKING TEMPERATURE**  
-10°C ÷ +50°C

**STORAGE TEMPERATURE**  
-25°C ÷ +75°C

### PACKAGE

1 reader/writer, 1 Vimar Idea Rondò plastic plate color black, 1 installation manual.  
Note: 503 box not included.

### ACCESSORIES (NOT INCLUDED)

- Electric lock actuator (code 5E2501)

cod. E03222



Accessories

### DIMENSIONS

Frame mounting rectangular version Vimar Idea frame and rectangular box compatible

- Width: 120 mm
- Height: 55 mm
- Depth: 82 mm

### ONLINE CONTENT

Web page

Specifications

Data sheet

Installation guide



## F9000 Readers and validators Wall mounted validator

THE F9000 READERS/WRITERS CAN BE CONNECTED TO THE ATLAS OFFLINE SEVER IN ORDER TO CREATE, VALIDATE AND UPDATE THE F9000 KEYS

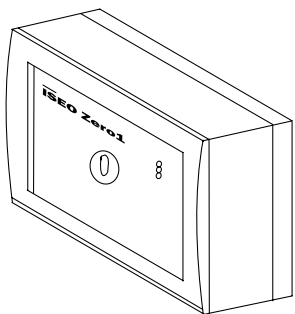

### Technical features

**FIRMWARE**  
1RIS

**POWER UNIT**  
10 -24Vdc - Powered through connection to the ATLAS server

**ALERTS**  
- Led 3-colour series green, red, blue

**PRODUCT COMPATIBILITY**  
- The F9000 readers/writers can be connected to the ATLAS offline sever in order to create, validate and update the F9000 keys with V2 firmware and F9000 ON/UP/EM/PR keys. Connecting an electric lock actuator it is possible to control a gate in online mode.

**MOUNTING**  
- Wall mounted

**WORKING TEMPERATURE**  
-10°C ÷ +50°C

**STORAGE TEMPERATURE**  
-25°C ÷ +75°C

**PACKAGE**  
1 reader/writer, 1 installation manual.

**ACCESSORIES (NOT INCLUDED)**  
- Electric lock actuator (code 5E2501)

cod. E03262

Accessories

### DIMENSIONS

Wall mounting Vimar Idea plastic box

- Width: 123 mm
- Height: 55 mm
- Depth: 88 mm

### ONLINE CONTENT

Web page

Data sheet

Installation guide

Specifications

## F9000 Readers and validators IP55 Wall mounted validator with protective flap

THE F9000 READER/WRITER CAN BE CONNECTED TO THE ATLAS OFFLINE SEVER IN ORDER TO CREATE, VALIDATE AND UPDATE THE F9000 KEYS

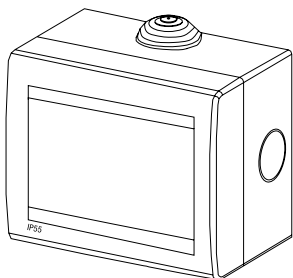

### Technical features

**FIRMWARE**  
1RIS

**POWER UNIT**  
10 -24Vdc - Powered through connection to the ATLAS server

**ALERTS**  
- Led 3-colour series green, red, blue

**PRODUCT COMPATIBILITY**  
- The F9000 readers/writers can be connected to the ATLAS offline sever in order to create, validate and update the F9000 keys with V2 firmware and F9000 ON/UP/EM/PR keys. Connecting an electric lock actuator it is possible to control a gate in online mode.

**MOUNTING**  
- Wall mounted

**ENVIRONMENTAL FEATURES**  
- IP55

**WORKING TEMPERATURE**  
-25°C ÷ +50°C

**STORAGE TEMPERATURE**  
-25°C ÷ +75°C

**PACKAGE**  
1 reader/writer, 1 installation manual.

**ACCESSORIES (NOT INCLUDED)**  
- Electric lock actuator (code 5E2501)

cod. E03232



### DIMENSIONS

Wall mounting IP55 version Vimar Idea IP55 plastic box

- Width: 120 mm
- Height: 55 mm
- Depth: 82 mm

### ONLINE CONTENT

 Web page

 Specifications

 Data sheet

 Installation guide

## F9000 Readers and validators Heavy Duty vandal-proof validator

THE F9000 READER/WRITERS CAN BE CONNECTED TO THE ATLAS OFFLINE SEVER IN ORDER TO CREATE, VALIDATE AND UPDATE THE F9000 KEYS

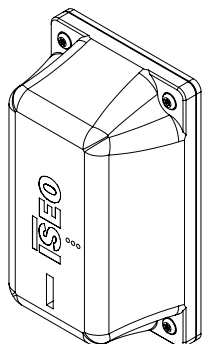

### Technical features

**FIRMWARE**  
1RIS

**POWER UNIT**  
10 -24Vdc - Powered through connection to the ATLAS server

**ALERTS**  
- Led 3-colour series green, red, blue

**PRODUCT COMPATIBILITY**  
- The F9000 readers/writers can be connected to the ATLAS offline sever in order to create, validate and update the F9000 keys with V2 firmware and F9000 ON/UP/EM/PR keys. Connecting an electric lock actuator it is possible to control a gate in online mode.

**MOUNTING**  
- Wall mounted

**ENVIRONMENTAL FEATURES**  
- IP66  
- IP67  
- IP69  
- Impact protection degree IK10  
- High Corrosion Resistance: Tested for 480 hours in NSS (Neutral Salt Spray)

**WORKING TEMPERATURE**  
-40°C ÷ +80°C

**STORAGE TEMPERATURE**  
-40°C ÷ +80°C

**PACKAGE**  
1 reader/writer, fixing screws, 1 installation manual

**ACCESSORIES (NOT INCLUDED)**  
- Electric lock actuator (code 5E2501)

cod. E03201



### DIMENSIONS

Solid metal antivandal housing

- Width: 150 mm
- Height: 53 mm
- Depth: 90 mm

### ONLINE CONTENT

 [Web page](#)

 [Specifications](#)

 [Data sheet](#)

 [Installation guide](#)

## F9000 Readers and validators

### Accessories

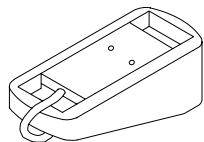

#### RFID MODEM FOR RFID OFF-LINE DEVICES

In combination with a notebook, equipped with the ISEO communication software "Hermes SW", it is used to program, to synchronize and log readout. the offline RFID devices. USB interface. Plastic adapter included.

Package: 1 modem with plastic adapter.

1 541E00010

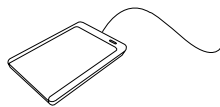

#### DESKTOP RFID READER/WRITER

USB interface. Multicolor signaling LEDs.

Package: 1 reader/writer.

1 E03200

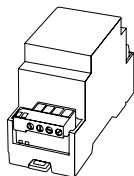

#### ELECTRIC LOCK ACTUATOR

1 relay + 1 booster. 3 inputs (1 digital, 1 analog, 1 digital/analog)  
Lockbus interface. 8-30Vdc Power Supply.  
DIN35 rail mounting.

Package: 1 actuator, instruction manual.

1 5E2501



#### ELECTRICAL JUMPER

For special multidevice configurations.

5 5E00000205

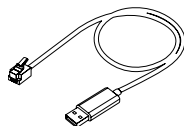

#### SERIAL COMMUNICATION CABLE FOR ATLAS

USB - serial cable for Atlas programming.

Package: 1 cable

1 0000IS00243

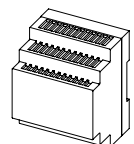

#### POWER SUPPLY UNIT 24Vdc - 30W

Input 100-240Vac. Output 24Vdc 1.5A.  
DIN35 rail mounting.

Package: 1 power supply unit, instruction manual.

1 5E3506

#### POWER SUPPLY UNIT 12Vdc - 70W

Input 120-230Vac. Output 12Vdc 6A.  
DIN35 rail mounting.

Package: 1 power supply unit, instruction manual.

1 5E3509

Search by device

## **Network and system devices**

# Atlas Controllers



## The system controllers

The management of authorizations and credentials in the ISEO access control system is carried out by the ATLAS controller, the true "heart" of the system. The ATLAS controller contains data relating to all offline and online devices and all system credentials.

## For architectures of various dimensions

Multiple ATLAS in Slave mode can be installed on the same system to manage different validators and doors, even geographically distributed ones.

## Product features

- Contains the list of all offline and online devices and the credentials database
- Manages credential creation, updating and validation via RFID card validators (INCA) or F9000 key validators
- The ATLAS controller can be used to manage offline RFID devices, such as MA1A, Aries and Libra, or F9000 mechatronic cylinders
- Atlas PLUS version as Master controller for systems with V364 software

### FINISH

 Technopolymer

### COLOR

 White

### COMMUNICATION INTERFACE

- Ethernet TCP/IP 10/100 base-T
- Lockbus
- RS485
- USB type B
- Serial

Go to page

### MODELS

- Atlas Plus DIN controller for RFID devices and F9000 p. 143
- Atlas Plus controller for RFID devices and F9000 p. 144

## Atlas Controllers Atlas Plus DIN controller for RFID devices and F9000

### CONTROLLER FOR MANAGING AUTHORIZATIONS AND CREDENTIALS IN THE ISEO ACCESS CONTROL SYSTEM

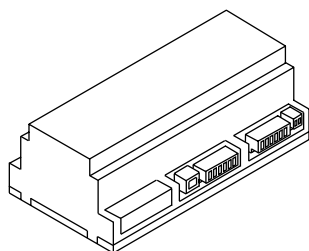

Click on the product code to download the right datasheet

Version 12-24 V DC POWER SUPPLY	<b>5E052014</b>
---------------------------------	-----------------

Version P.O.E. (Power Over Ethernet)	<b>5E052016</b>
--------------------------------------	-----------------

 Accessories

#### DIMENSIONS

- Height: 61 mm
- Width: 160 mm
- Depth: 90 mm

### Technical features

**FIRMWARE**  
1RIS

**POWER UNIT**  
12÷24 Vac (max. 15W)  
1500mAh emergency battery pack

**ESTIMATED BATTERY LIFE**  
Estimated duration 30 min without power supply

#### HARDWARE SPECIFICATIONS

- ARM 9 based CPU module
- 800MHz CPU clock
- 512MByte memory
- 8GB Micro-SD
- Real Time Clock

#### ALERTS

- 12 LEDs - Power (green) - Battery running (yellow) - Ethernet network (orange) - Tx/Rx channel 1 (2x orange) - Tx/Rx channel 2 (2x orange) - Tx/Rx channel 3 (2x orange) - User 1 and 2 (red and green)

#### PRODUCT COMPATIBILITY

- Compatible with Lockbus and RS485 readers and actuators.

#### MOUNTING

- DIN Rail 35 mounted

#### WORKING TEMPERATURE

0°C ÷ +50°C

#### STORAGE TEMPERATURE

-25°C ÷ +75°C

#### PACKAGE

1 controller with connectors, 1 installation manual.

Note: serial programming cable and power supplier not included.

#### ACCESSORIES (NOT INCLUDED)

- Electric lock actuator (cod. 5E2501)

### ONLINE CONTENT

 Web page

 Specifications

 Data sheet

 Advanced connections

 Installation guide

## Atlas Controllers Atlas Plus controller for RFID devices and F9000

CONTROLLER FOR MANAGING  
AUTHORIZATIONS AND CREDENTIALS  
IN THE ISEO ACCESS CONTROL SYSTEM

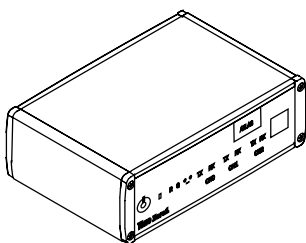

### Technical features

**FIRMWARE**  
1RIS

**POWER UNIT**  
12÷24 Vac (max. 15W)  
1500mAh emergency battery pack

**ESTIMATED BATTERY LIFE**  
Estimated duration 30 min without power supply

#### HARDWARE SPECIFICATIONS

- ARM 9 based CPU module
- 800MHz CPU clock
- 512MByte memory
- 8GB Micro-SD
- Real Time Clock

#### ALERTS

- 12 LEDs - Power (green) - Battery running (yellow) - Ethernet network (orange) - Tx/Rx channel 1 (2x orange) - Tx/Rx channel 2 (2x orange) - Tx/Rx channel 3 (2x orange) - User 1 and 2 (red and green)

#### PRODUCT COMPATIBILITY

- Compatible with Lockbus and RS485 readers and actuators.

**MOUNTING**  
- Desktop

**WORKING TEMPERATURE**  
0°C ÷ +50°C

**STORAGE TEMPERATURE**  
-25°C ÷ +75°C

#### PACKAGE

1 controller with connectors, 1 installation manual.  
Note: serial programming cable and power supplier not included.

cod. 5E002012



#### DIMENSIONS

- Height: 53 mm
- Width: 167 mm
- Depth: 110 mm

#### ONLINE CONTENT

 [Web page](#)

 [Data sheet](#)

 [Installation guide](#)

 [Specifications](#)

 [Advanced connections](#)



## Atlas Controllers

---

### Accessories

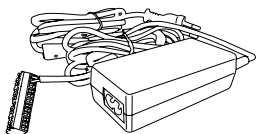

POWER SUPPLY UNIT 24Vdc - 36W (FOR ATLAS DIN)

Input 100-240Vac. Output 24Vdc 1.5A.

Desktop version, 2 pin standard plug.

Package: 1 power supply unit.

1

5E3005

# Gateways



## Validate your F9000 key via Bluetooth®

The V364 Gateway operates as validator for the F9000 ON keys. It communicates with the Atlas Master (V364 Classic) or Virtual Atlas Master (V364 on air or V364 Customer Hosted) with data connection and towards the F9000 ON keys with Bluetooth®.

The V364 Gateway can validate all the F9000 ON keys in its Bluetooth range (around 10 meters depending on environment conditions).

## Create completely online and wireless access control systems

Sofia HyperGate allows you to build completely online and wireless access control systems based on ISEO Argo locks. The HyperGate device allows you to remotely update the lock memory (white-list), authorize or deactivate new users, cards and smartphones. In addition, HyperGate allows remote opening of the passage, as well as reading of the lock history via browser or smartphone device remotely.

## Product's functions

- "Desktop" format with the possibility of wall mounting
- Data conversion (WIFI or Ethernet) to Bluetooth®

### FINISH

 Technopolymer

### COLOR

 White

Go to page

### MODELS

- V364 Gateway p. 147
- Hypergate Pro for Luckey p. 148
- Hypergate Lite for Luckey p. 149

## Gateways V364 Gateway

THE GATEWAY OPERATES AS F9000 VALIDATOR FOR THE F9000 ON KEYS IN ITS Bluetooth® RANGE (AROUND 10 METERS DEPENDING ON ENVIRONMENT CONDITIONS).

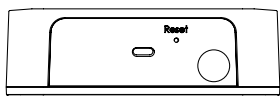
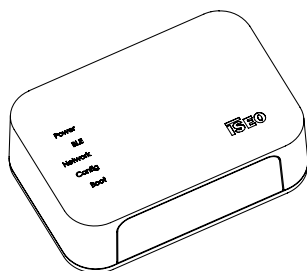

Click on the product code to download the right datasheet

Version WIFI	5E072524
--------------	----------

Version P.O.E. (Power Over Ethernet)	5E072514
--------------------------------------	----------

 Accessories

### DIMENSIONS

- Width: 125mm
- Depth: 40mm
- Height: 85mm

### Technical features

**FIRMWARE**  
1RIS

**POWER UNIT**  
Powered by USB C +5VDC input power 2A (10W).  
Power supply not included (accessory to order separately).

**HARDWARE SPECIFICATIONS**

- ARM A7 based CPU module
- 512 MB RAM
- 8 GB Flash eMMC Non volatile Memory

**PRODUCT COMPATIBILITY**

- Compatible with ISEO F9000 ON keys

**MOUNTING**

- Wall mounted
- Desktop

**WORKING TEMPERATURE**  
0°C ÷ +50°C

**STORAGE TEMPERATURE**  
-25°C ÷ +75°C

**PACKAGE**  
1 Gateway WIFI  
Power supply not included (accessory to order)

**ACCESSORIES (NOT INCLUDED)**

- Power supply (code 0000A00155)
- Wall fixing brackets kit (code 0000A00154)

### ONLINE CONTENT

 Data sheet

## Gateways HyperGate Pro for Luckey

GATEWAY IP/Bluetooth® TO BUILD COMPLETELY ONLINE AND WIRELESS ACCESS CONTROL SYSTEMS BASED ON ISEO ARGO LOCKS.

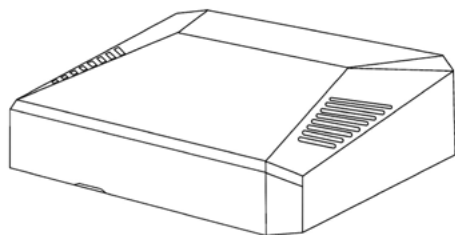

### Technical features

**FIRMWARE**  
SOFIA

**POWER UNIT**  
Powered by USB C +5VDC input power 2A (10W).  
Power supply not included (accessory to order separately).

**HARDWARE SPECIFICATIONS**  
- Bluetooth 4.0 (support to 5.0 included)  
- AES 256bits encryption

**ALERTS**  
- LEDs: 1 Green, 1 Red

**PRODUCT COMPATIBILITY**  
- Compatible with ISEO ARGO platform devices (Bluetooth®) managed with the Luckey application.  
- Connect up to 5 Smart Locks  
- Indoor range: Average 10m\*

\*Bluetooth® transmission total distance may vary depending on HyperGate Pro location and surrounding environment. For example walls, doors, glazed surfaces can reduce or stop the communication between the Smart Locks and the HyperGate Pro.

**MOUNTING**  
- Desktop

**WORKING TEMPERATURE**  
0°C ÷ +50°C

**PACKAGE**  
1 HyperGate Pro  
Power supply not included (accessory to order)

**ACCESSORIES (NOT INCLUDED)**  
- Alimentatore (code 004S105)

cod. 004S103

 Accessories

#### DIMENSIONS

Length: 10.6 cm  
Width: 9.6 cm  
Thickness: 3.3 cm

Weight  
2 Kg

#### ONLINE CONTENT

 Web page

 Data sheet

## Gateways HyperGate Lite for Luckey

MANAGE ACCESS CREDENTIALS IN REAL-TIME  
AND CONTROL SMART LOCKS REMOTELY

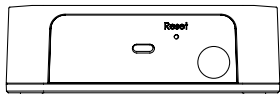
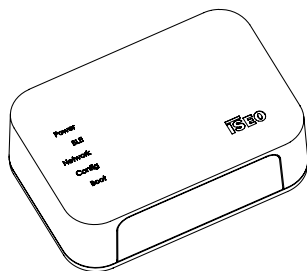

### Technical features

**FIRMWARE**  
SOFIA

**POWER UNIT**  
Powered by USB C +5VDC input power 2A (10W).  
Power supply not included (accessory to order separately).

**HARDWARE SPECIFICATIONS**

- ARM A7 based CPU module
- 512 MB RAM
- 8 GB Flash eMMC Non volatile Memory

**PRODUCT COMPATIBILITY**

- Compatible with ISEO ARGO platform devices (Bluetooth®) managed with the Luckey application (Basic and Enterprise)
- Indoor range: Average 10m\*

\*Bluetooth® transmission total distance may vary depending on HyperGate location and surrounding environment. For example walls, doors, glazed surfaces can reduce or stop the communication between the Smart Locks and the HyperGate.

**MOUNTING**

- Wall mounted
- Desktop

**WORKING TEMPERATURE**  
0°C ÷ +50°C

**STORAGE TEMPERATURE**  
-25°C ÷ +75°C

**PACKAGE**  
1 Gateway  
Power supply not included (accessory to order)

**ACCESSORIES (NOT INCLUDED)**

- Power supply (cod. 0000A00155)
- Wall fixing brackets kit (cod. 0000A00154)

Click on the product code to download the right datasheet

Version WIFI **5E07S524**



Version P.O.E. (Power Over Ethernet) **5E07S514**

 Accessories

### DIMENSIONS

- Width: 125mm
- Depth: 40mm
- Height: 85mm

### ONLINE CONTENT

-  Web page
-  Data sheet

## Gateways

### Accessories

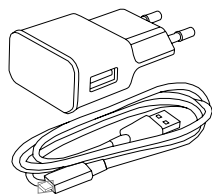

#### POWER SUPPLY FOR V364 GATEWAY AND HYPERGATE LITE

IN = 100-240V50-60Hz 0.50A

OUT = 5.0Vdc 2A (10W)

USB A to USB C 1.5 mt cable

1 0000A00155

#### POWER SUPPLY FOR HYPERGATE PRO

IN = 100-240V50-60Hz 0.50A

OUT = 5.0Vdc 3A (15W)

USB A to USB C 1.5 mt cable

1 004S105

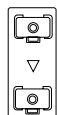
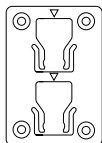

#### WALL FIXING BRACKETS KIT FOR V364 GATEWAY AND HYPERGATE LITE

nr. 1 Wall bracket

nr. 1 Gateway bracket

nr. 2 Screws

nr. 4 Wall plugs and screws

1 0000A00154



# RFID credentials

---

## MIFARE DESFIRE EV2 8K



**USER CARD (ISEO LOGO)**  
 RFID card. Mifare DESFire EV2 8K.  
 ISEO logo on both sides. UID printed.

Mifare DESFire EV2 8K 10 5E405200

---



**USER CARD (BLANK)**  
 RFID card. Mifare DESFire EV2 8K.  
 Blank on both sides. UID printed.  
 (available for customer personalization)

Mifare DESFire EV2 8K - with UID printed 10 5E405220

---



**KEYFOB TRANSPONDER (ISEO LOGO)**  
 RFID TAG. Mifare DESFire EV2 8K.  
 GREY. ISEO Logo. UID printed.

Mifare DESFire EV2 8K - with UID printed on the back 10 5E415200

---

# RFID credentials

---

## MIFARE CLASSIC 4K



**USER CARD (ISEO LOGO)**  
 RFID card. Mifare Classic 4K.  
 ISEO Logo on both sides. UID printed.

Mifare Classic 4K	10	5E402100
-------------------	----	----------



**UID CARD (BLANK)**  
 RFID card.  
 Blank on both sides.  
 (available for customer personalization).

Mifare Classic 4K - without UID printed	10	5E402110
---	----	----------

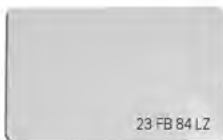

Mifare Classic 4K - with UID printed	10	5E402120
--------------------------------------	----	----------



**KEYFOB TRANSPONDER (NEUTRAL)**  
 TAG RFID. Mifare Classic 4K.  
 GREY. Neutral on both sides.

Mifare Classic 4K - without UID printed	10	KEYFOB1356MF4
---	----	---------------



## Code configurator

---

Some products are available in different versions to suit customer requirements and the characteristics of the doors on which they are to be installed. Please use the configurator of the specific product model to create the code you wish to order.

# Aries 2.0 Standard

## ELECTRONIC TRIM SET STANDARD

## CODE CONFIGURATOR

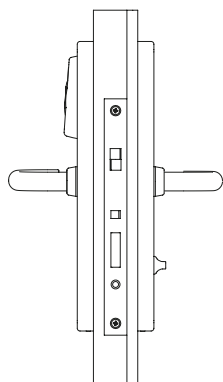

0 0 E 1    1 5 2

- Without cylinder hole in the cover 1
  - VISIBLE cylinder hole - center distance 85 mm 2
  - VISIBLE cylinder hole - center distance 92 mm 3
  - VISIBLE cylinder hole - center distance 70 mm 4
  - VISIBLE cylinder hole - center distance 72 mm 5
  - VISIBLE cylinder hole - center distance 88 mm 6
- 
- Internal usage version (IP54) 1
  - External usage version (IP55) 5
- 
- FINISHES
- 2 Inox
- 
- 1 Electric emergency – with privacy \*
  - 2 Electric emergency – without privacy \*
  - 3 Mechanical emergency – with privacy
  - 4 Mechanical emergency – without privacy

\* ONLY compatible to configuration  
Without cylinder hole in the cover  
(code 1 in fifth position)

## Product options

### OVERRIDE CYLINDER HOLE EXTERNAL SIDE

### IP RATING

To chose if a mechanical emergency cylinder is used. The mechanical cylinder is still accessible without cylinder hole, by turning the plate.

For internal (IP54) or external (IP55) usage.

### EMERGENCY OVERRIDE CYLINDER

High Security Iseo R90 Factory Monoprofile. Up to 3 mechanical recordings. Usage detected by electronics. KA on the same installation.

### EXTERNAL EMERGENCY POWER SUPPLY

For installations with no override cylinder. Connector under external cover plate. Standard 9V battery usage.

### PRIVACY DEVICE

Internal ergonomic knob to activate privacy. Signal reset after each door opening.

## Aries 2.0 For panic devices

### ELECTRONIC TRIM SET FOR PANIC DEVICES

### CODE CONFIGURATOR

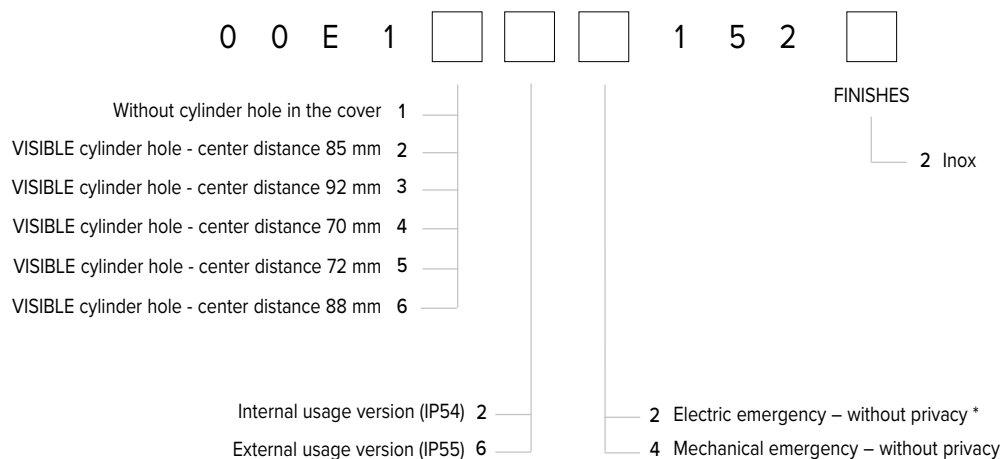
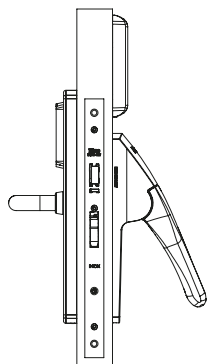

\* ONLY compatible to configuration  
Without cylinder hole in the cover  
(code 1 in fifth position)

### Product options

#### OVERRIDE CYLINDER HOLE EXTERNAL SIDE

#### IP RATING

To chose if a mechanical emergency cylinder is used. The mechanical cylinder is still accessible without cylinder hole, by turning the plate.

For internal (IP54) or external (IP55) usage.

#### EMERGENCY OVERRIDE CYLINDER

High Security Iseo R90 Factory Monoprofile. Up to 3 mechanical recordings. Usage detected by electronics. KA on the same installation.

#### EXTERNAL EMERGENCY POWER SUPPLY

For installations with no override cylinder. Connector under external cover plate. Standard 9V battery usage.

## Aries 2.0 For custom handles

### ELECTRONIC TRIM SET FOR CUSTOM HANDLES

### CODE CONFIGURATOR

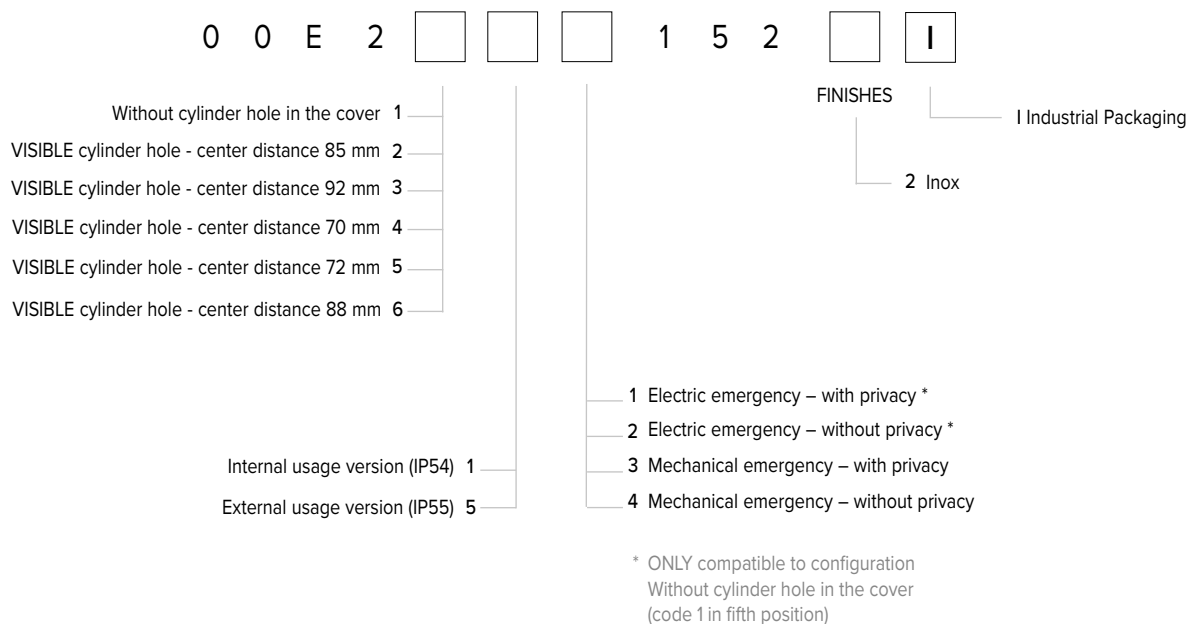
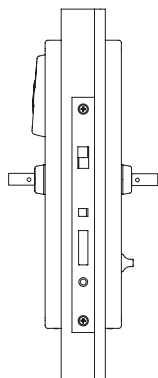

### Product options

#### OVERRIDE CYLINDER HOLE EXTERNAL SIDE

To chose if a mechanical emergency cylinder is used. The mechanical cylinder is still accessible without cylinder hole, by turning the plate.

#### IP RATING

For internal (IP54) or external (IP55) usage.

#### EMERGENCY OVERRIDE CYLINDER

High Security Iseo R90 Factory Monoprofile. Up to 3 mechanical recordings. Usage detected by electronics. KA on the same installation.

#### EXTERNAL EMERGENCY POWER SUPPLY

For installations with no override cylinder. Connector under external cover plate. Standard 9V battery usage.

#### PRIVACY DEVICE

Internal ergonomic knob to activate privacy. Signal reset after each door opening.

## Aries 2.0 For custom handles for panic devices

### ELECTRONIC TRIM SET FOR PANIC DEVICES

### CODE CONFIGURATOR

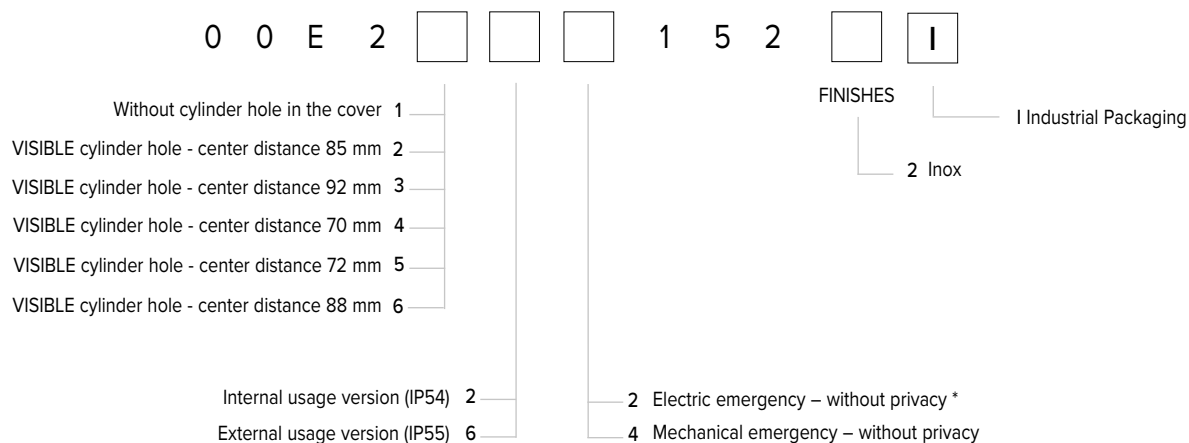
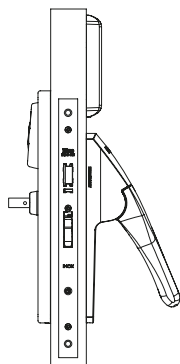

\* ONLY compatible to configuration  
Without cylinder hole in the cover  
(code 1 in fifth position)

### Product options

#### OVERRIDE CYLINDER HOLE EXTERNAL SIDE

#### IP RATING

To chose if a mechanical emergency cylinder is used. The mechanical cylinder is still accessible without cylinder hole, by turning the plate.

For internal (IP54) or external (IP55) usage.

#### EMERGENCY OVERRIDE CYLINDER

High Security Iseo R90 Factory Monoprofile. Up to 3 mechanical recordings. Usage detected by electronics. KA on the same installation.

#### EXTERNAL EMERGENCY POWER SUPPLY

For installations with no override cylinder. Connector under external cover plate. Standard 9V battery usage.

# Aries 2.0 For DIN lock

## ELECTRONIC TRIM SET FOR DIN LOCK

## CODE CONFIGURATOR

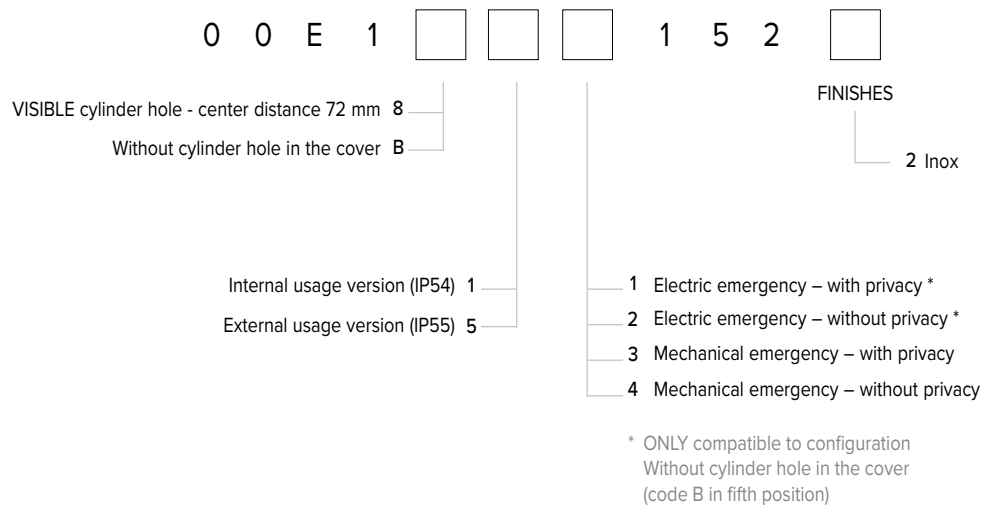
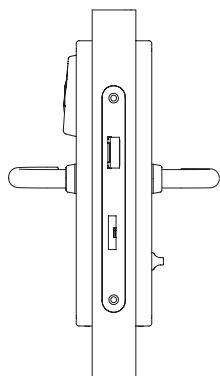

### Product options

#### OVERRIDE CYLINDER HOLE EXTERNAL SIDE

#### IP RATING

#### EMERGENCY OVERRIDE CYLINDER

#### EXTERNAL EMERGENCY POWER SUPPLY

#### PRIVACY DEVICE

To chose if a mechanical emergency cylinder is used. The mechanical cylinder is still accessible without cylinder hole, by turning the plate.

For internal (IP54) or external (IP55) usage.

High Security Iseo R90 Factory Monoprofile. Up to 3 mechanical recodings. Usage detected by electronics. KA on the same installation.

For installations with no override cylinder. Connector under external cover plate. Standard 9V battery usage.

Internal ergonomic knob to activate privacy. Signal reset after each door opening.

## Aries 2.0 For fire locks

### ELECTRONIC TRIM SET FOR FIRE LOCKS

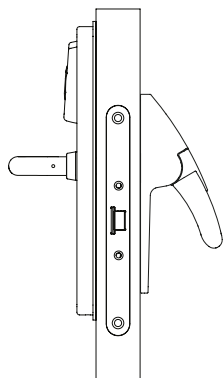

### CODE CONFIGURATOR

0 0 E 1 9  0 1 5 2

Internal usage version (IP54) 2  
 External usage version (IP55) 6

FINISHES  
 2 Inox

### Product options

#### IP RATING

For internal (IP54) or external (IP55) usage.

## Aries 2.0 For Premi Apri Meroni locks

### ELECTRONIC TRIM SET

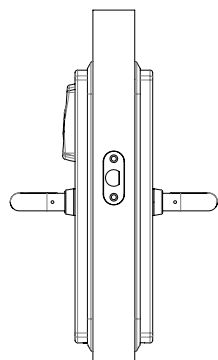

### CODE CONFIGURATOR

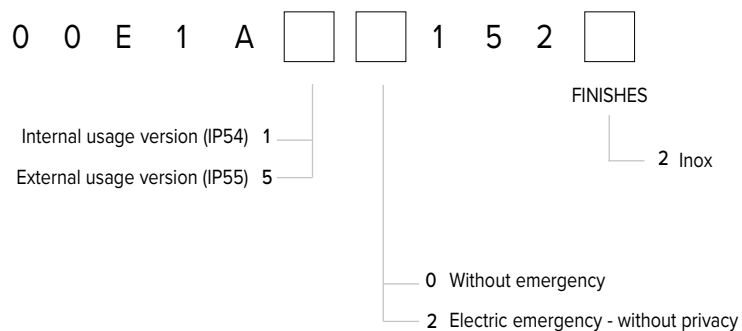

### Product options

IP RATING	EMERGENCY OVERRIDE CYLINDER	EXTERNAL EMERGENCY POWER SUPPLY	PRIVACY DEVICE
For internal (IP54) or external (IP55) usage.	High Security Iseo R90 Factory Monoprofile. Up to 3 mechanical recodings. Usage detected by electronics. KA on the same installation.	For installations with no override cylinder. Connector under external cover plate. Standard 9V battery usage.	Internal ergonomic knob to activate privacy. Signal reset after each door opening.



## Libra LE60 2.1 Standard

MODULAR CYLINDER WITH EXTERNAL ELECTRONIC KNOB (FREE ROTATION) AND INTERNAL MECHANICAL KNOB (STANDARD TYPE)

### CODE CONFIGURATOR

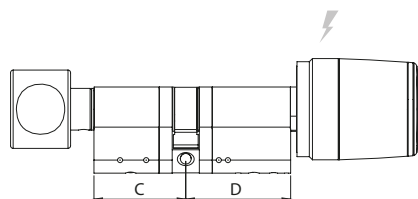

8 M K		8			6 2	
		DIMENSION		DIMENSION		FINISHES
		C	D			
Heavy Duty	1	30 <sup>**/****</sup>	30	P PANIC function <sup>***</sup> / <sup>****</sup>		
Standard	2	35	35			
Removable external knob (Heavy Duty) <sup>**</sup> / <sup>****</sup>	4	40	40			
		45	45			
		50	50			
		55	55			
		60	60			
		65	65			
	70	70				
	75	75				
	...	...				
	...	...				
	130	130				

L max 260 mm

— 25 Inox - Black  
 — 23 Inox - Metal Grey  
 — L5 Polished Brass - Black\*  
 — K4 Polished Chrome - White

### Product options

#### HEAVY DUTY LIBRA KNOB

Version with drilling protection on the opening mechanism. IP rating IP66.

#### REMOVABLE EXTERNAL KNOB

Removable knob (Heavy Duty characteristics).

#### PANIC VERSION FOR PANIC LOCK

Freely rotating with cam returning in vertical position.

\* not suitable for outdoor installations  
 \*\* not available Panic function version  
 \*\*\* not compatible with version "external removable knob"  
 \*\*\*\* L max 180 mm (L max per side 90 mm)

## Libra LE60 2.1 Premium

MODULAR CYLINDER WITH EXTERNAL ELECTRONIC KNOB (FREE ROTATION) AND INTERNAL MECHANICAL KNOB (PREMIUM TYPE)

### CODE CONFIGURATOR

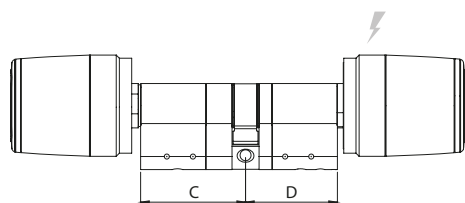

8 M K		0				6 2	
			DIMENSION C	DIMENSION D	FINISHES		
Heavy Duty	1		30**/***	30	P PANIC function ***/****		
Standard	2		35	35			
Removable external knob (Heavy Duty) **/****	4		40	40			
			45	45			
			50	50			
			55	55			
			60	60			
			65	65			
		70	70				
		75	75				
		...	...				
		...	...				
		130	130				

L max 260 mm

- 25 Inox - Black
- 23 Inox - Metal Grey
- L5 Polished Brass - Black\*
- K4 Polished Chrome - White

### Product options

#### HEAVY DUTY LIBRA KNOB

Version with drilling protection on the opening mechanism. IP rating IP66.

#### REMOVABLE EXTERNAL KNOB

Removable knob (Heavy Duty characteristics).

#### PANIC VERSION FOR PANIC LOCK

Freely rotating with cam returning in vertical position.

\* not suitable for outdoor installations  
 \*\* not available Panic function version  
 \*\*\* not compatible with version "external removable knob"  
 \*\*\*\* L max 180 mm (L max per side 90 mm)

## Libra LE60 2.1 Half

MODULAR HALF KNOB CYLINDER WITH EXTERNAL ELECTRONIC KNOB (FREE-ROTATING)

### CODE CONFIGURATOR

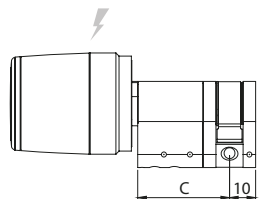

8 M K  0  1 0  6 2

	DIMENSION C	DIMENSION D	FINISHES
Heavy Duty 1	30 **		
Standard 2	35		
Removable external knob (Heavy Duty) ***	40		
	45		
	50		
	55		
	60		
	65		
	70		25 Inox - Black
	75		23 Inox - Metal Grey
	...		L5 Polished Brass - Black *
	...		K4 Polished Chrome - White
	180		

L max 190 mm

\* not suitable for outdoor installations  
 \*\* Libra monoprofile 30/10 removable reader is not modular. Length 35/10 and up is modular.  
 \*\*\* L max 90/10

### Product options

#### HEAVY DUTY LIBRA KNOB

Version with drilling protection on the opening mechanism. IP rating IP66.

#### REMOVABLE EXTERNAL KNOB

Removable knob (Heavy Duty characteristics).

## Libra LE60 2.1 Double

MODULAR CYLINDER WITH EXTERNAL ELECTRONIC KNOB (FREE-ROTATING) AND INTERNAL ELECTRONIC KNOB (FREE-ROTATING)

### CODE CONFIGURATOR

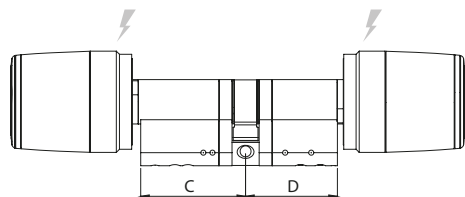

8 M K  E    6 2

	DIMENSION C	DIMENSION D	FINISHES
Heavy Duty 1		30	<input type="checkbox"/> 25 Inox - Black <input type="checkbox"/> 23 Inox - Metal Grey <input type="checkbox"/> L5 Polished Brass - Black * <input type="checkbox"/> K4 Polished Chrome - White
Standard 2	35	35	
	40	40	
	45	45	
	50	50	
	55	55	
	60	60	
	65	65	
	70	70	
	75	75	
	...	...	
	...	...	
	90	90	

L max 180 mm

\* not suitable for outdoor installations

\*\*C = side with removable electronic knob

### Product options

#### HEAVY DUTY LIBRA KNOB

Version with drilling protection on the opening mechanism. IP rating IP66.

## Libra LE60 2.1 Removable reader and Extension plug 16 mm

MODULAR CYLINDER FOR ARMORED DOORS WITH EXTERNAL ELECTRONIC KNOB (FREE ROTATION), COMPATIBLE WITH CYLINDERS ESCUTCHEON, EXTENSION PLUG AND PRE-ARRANGED FOR INTERNAL KNOB SHAFT D 8X16 mm

### CODE CONFIGURATOR

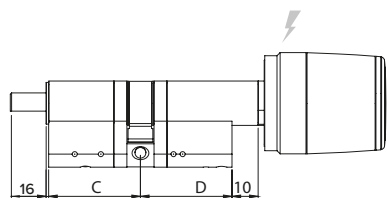

8 M K 3 6



6 2

DIMENSION

DIMENSION

FINISHES

C

D

30

30

35

35

40

40

45

45

50

50

55

55

60

60

70

70

...

...

...

...

90

85

L max 175 mm

- 25 Inox - Black
- 23 Inox - Metal Grey
- L5 Polished Brass - Black \*
- K4 Polished Chrome - White

\* not suitable for outdoor installations

### Product options

HEAVY DUTY  
LIBRA KNOB

Version with drilling protection on the opening mechanism. IP rating IP66.

## Libra LE60 2.1 Removable reader and Extension plug 75 mm

MODULAR CYLINDER FOR ARMORED DOORS WITH EXTERNAL ELECTRONIC KNOB (FREE ROTATION), COMPATIBLE WITH CYLINDERS ESCUTCHEON, EXTENSION PLUG AND PRE-ARRANGED FOR INTERNAL KNOB SHAFT D 8X75 mm

### CODE CONFIGURATOR

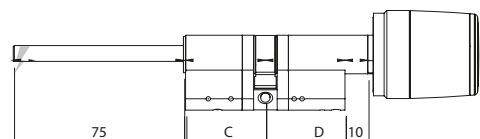

8 M K 3 6    D 0              6 2

DIMENSION  
C

DIMENSION  
D

FINISHES

30  
35  
40  
45  
50  
55  
60  
70  
...  
...  
85

- 25 Inox - Black
- 23 Inox - Metal Grey
- L5 Polished Brass - Black\*
- K4 Polished Chrome - White

L max 115 mm

\* not suitable for outdoor installations.

### Product options

#### HEAVY DUTY LIBRA KNOB

Version with drilling protection on the opening mechanism. IP rating IP66.

## Libra LE60 2.1 Dummy-knob

MODULAR CYLINDER FOR ARMORED DOORS  
WITH EXTERNAL ELECTRONIC KNOB (FREE ROTATION)  
AND KNOB-DUMMY ON INTERNAL SIDE

### CODE CONFIGURATOR

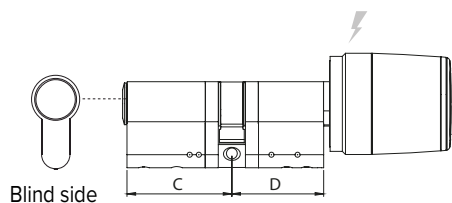

8 M K		C				6 2	
		DIMENSION	DIMENSION	FINISHES			P PANIC function ***/**
		C	D				
Heavy Duty	1	30**/**	30				
Standard	2	35	35				
Removable external knob (Heavy Duty) **/**	4	40	40				
		45	45				
		50	50				
		55	55				
		60	60				
		65	65				
		70	70				
		75	75				
		...	...				
		...	...				
		130	130				
		L max 260 mm					
				25 Inox - Black			
				23 Inox - Metal Grey			
				L5 Polished Brass - Black *			
				K4 Polished Chrome - White			

### Product options

#### HEAVY DUTY LIBRA KNOB

Version with drilling protection on the opening mechanism. IP rating IP66.

#### REMOVABLE EXTERNAL KNOB

Removable knob  
(Heavy Duty characteristics).

#### PANIC VERSION FOR PANIC LOCK

Freely rotating with cam returning  
in vertical position.

\* not suitable for outdoor installations  
\*\* not available Panic function version  
\*\*\* not compatible with version "external removable knob"  
\*\*\*\* L max 180 mm (L max per side 90 mm)

## Libra LE60 2.1 Oval Australian

OVAL AUSTRALIAN ELECTRONIC CYLINDER WITH EXTERNAL ELECTRONIC KNOB (FREE ROTATION)

### CODE CONFIGURATOR

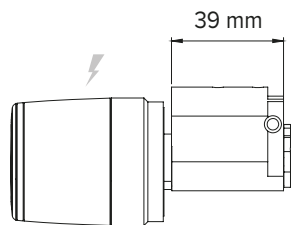

8 S K  9 0 0      6 2

Heavy Duty 1  
 Standard 2

DIMENSION

39

FINISHES

- 25 Inox - Black
- 23 Inox - Metal Grey
- L5 Polished Brass - Black \*
- K4 Polished Chrome - White

\* not available for Heavy Duty version  
 delivery time on request

### Product options

HEAVY DUTY  
 LIBRA KNOB

Version with drilling protection on the opening mechanism. IP rating IP66.



## Libra LE60 2.1 Oval Scandinavian

OVAL SCANDINAVIAN ELECTRONIC CYLINDER WITH EXTERNAL ELECTRONIC KNOB (FREE ROTATION)

### CODE CONFIGURATOR

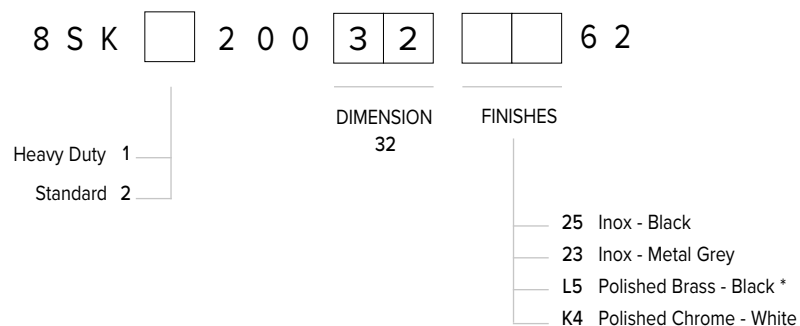
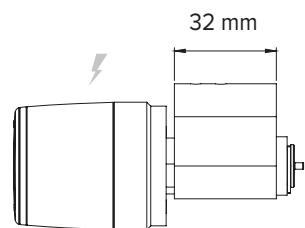

\* not available for Heavy Duty version  
 delivery time on request

### Product options

HEAVY DUTY  
 LIBRA KNOB

Version with drilling protection on the opening mechanism. IP rating IP66.

## F9000 Cylinders V3 Standard

MODULAR LE60 CYLINDER,  
DOUBLE NICKEL-PLATED EUROPEAN PROFILE,  
MECHATRONIC ON ONE SIDE ONLY

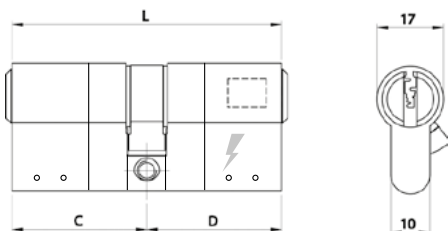
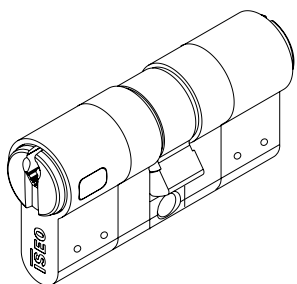

### CODE CONFIGURATOR

8 M V A	<input type="text"/>	<input type="text"/>	<input type="text"/>	9 M	<input type="text"/>	<input type="text"/>
	Standard 0					
	Double Function 9					
		DIMENSION	DIMENSION			
		C	D			
		30	30			
		35	35			
		40	40			
		45	45			
		50	50			
		55	55			
		60	60			
		65	65			
		70	70			
		...	...			
		180	180			

L max 260 mm

(\*) delivery time on request

### Product options

#### F9000 ATEX VERSION

The F9000 keys (ON, UP, PR, EM) and F9000 cylinders are available as an option for areas at risk of explosion where explosive or flammable gases may be present. The ATEX version of the keys and cylinders is certified ATEX EX 2 G Ex ib IIB T4 (zone 1).

#### VDS BZ+ CERTIFIED VERSION

The VDS BZ+ certified version is available on request.

## F9000 Cylinders V3 Standard Free Cam

MODULAR LE60 CYLINDER,  
DOUBLE NICKEL-PLATED EUROPEAN PROFILE,  
SINGLE-SIDED MECHATRONIC, FREE CAM

### CODE CONFIGURATOR

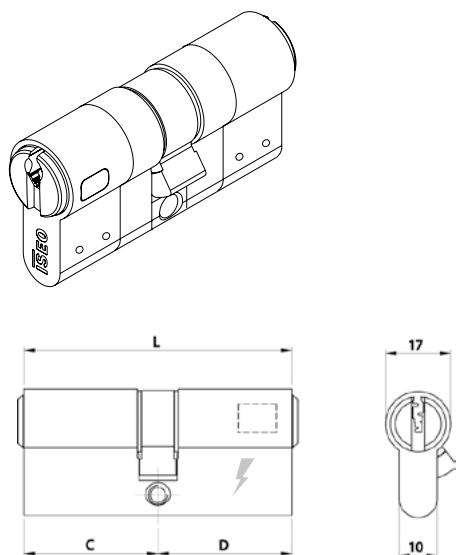

8 M V A L	<input type="text"/>	<input type="text"/>	9 M	<input type="text"/>	<input type="text"/>
	DIMENSION	DIMENSION			
	C	D			
	30	30			
	35	35			
	40	40			
	45	45			
	50	50			
	55	55			
	60	60			
	65	65			
	70	70			
	...	...			
	95	95			

EX ATEX version \*  
VD VDS version \*

L max 125 mm

(\*) delivery time on request

### Product options

#### F9000 ATEX VERSION

The F9000 keys (ON, UP, PR, EM) and F9000 cylinders are available as an option for areas at risk of explosion where explosive or flammable gases may be present. The ATEX version of the keys and cylinders is certified ATEX EX 2 G Ex ib IIB T4 (zone 1).

#### VDS BZ+ CERTIFIED VERSION

The VDS BZ+ certified version is available on request.

## F9000 Cylinders V3 Double

MODULAR LE60 CYLINDER,  
 DOUBLE NICKEL-PLATED EUROPEAN PROFILE,  
 MECHATRONIC ON BOTH SIDES

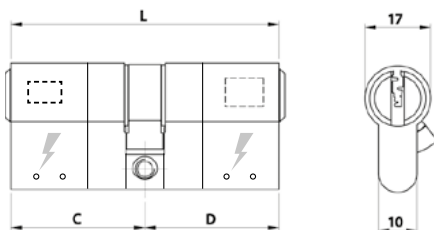
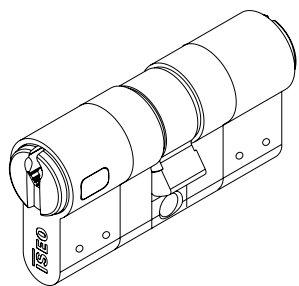

### CODE CONFIGURATOR

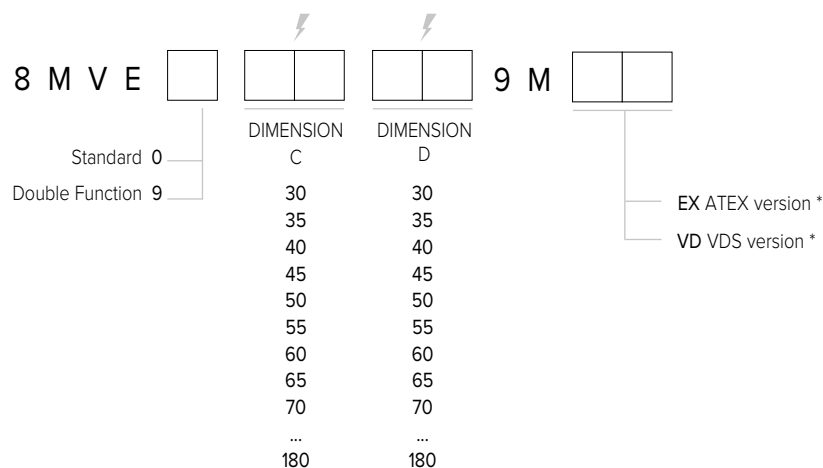

L max 260 mm

(\*) delivery time on request

EX ATEX version \*  
 VD VDS version \*

### Product options

#### F9000 ATEX VERSION

The F9000 keys (ON, UP, PR, EM) and F9000 cylinders are available as an option for areas at risk of explosion where explosive or flammable gases may be present. The ATEX version of the keys and cylinders is certified ATEX EX 2 G Ex ib IIB T4 (zone 1).

#### VDS BZ+ CERTIFIED VERSION

The VDS BZ+ certified version is available on request.

## F9000 Cylinders V3 Double Free Cam

MODULAR LE60 CYLINDER,  
DOUBLE NICKEL-PLATED EUROPEAN PROFILE,  
MECHATRONIC ON BOTH SIDES, FREE CAM

### CODE CONFIGURATOR

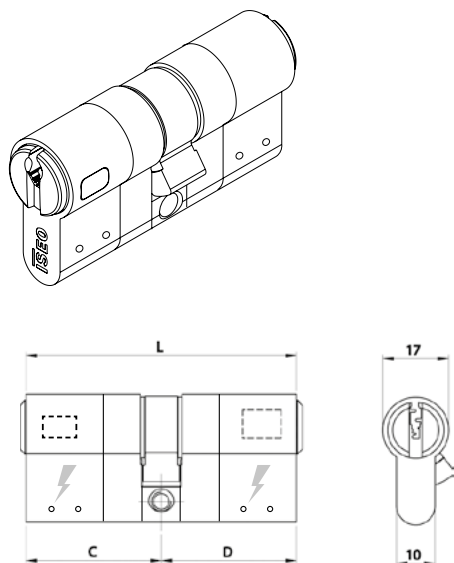

	⚡	⚡	
8 M V E L			9 M
	DIMENSION C	DIMENSION D	
	30	30	EX ATEX version *
	35	35	
	40	40	
	45	45	
	50	50	
	55	55	
	60	60	
	65	65	
	70	70	
	...	...	
	95	95	

L max 125 mm

(\*) delivery time on request

### Product options

#### F9000 ATEX VERSION

The F9000 keys (ON, UP, PR, EM) and F9000 cylinders are available as an option for areas at risk of explosion where explosive or flammable gases may be present. The ATEX version of the keys and cylinders is certified ATEX EX 2 G Ex ib IIB T4 (zone 1).

#### VDS BZ+ CERTIFIED VERSION

The VDS BZ+ certified version is available on request.

## F9000 Cylinders V3 Knob

MODULAR LE60 CYLINDER,  
DOUBLE NICKEL-PLATED EUROPEAN PROFILE,  
MECHATRONIC ON ONE SIDE ONLY,  
ROUND KNOB ON THE MECHANICAL SIDE

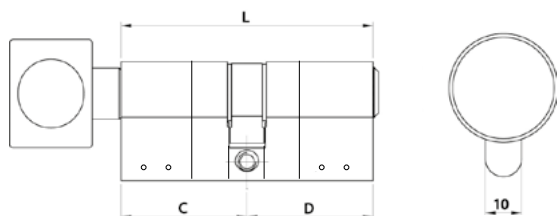
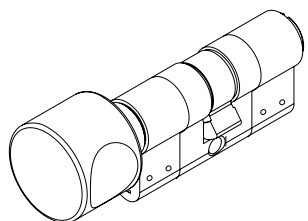

### CODE CONFIGURATOR

8 M V A 8	<input type="text"/>	<input type="text"/>	9 M	<input type="text"/>
	DIMENSION	DIMENSION		
	C	D		
	30	30		
	35	35		
	40	40		
	45	45		
	50	50		
	55	55		
	60	60		
	65	65		
	70	70		
	...	...		
	180	180		

L max 260 mm

(\*) delivery time on request

EX ATEX version \*  
VD VDS version \*

### Product options

#### F9000 ATEX VERSION

The F9000 keys (ON, UP, PR, EM) and F9000 cylinders are available as an option for areas at risk of explosion where explosive or flammable gases may be present. The ATEX version of the keys and cylinders is certified ATEX EX 2 G Ex ib IIB T4 (zone 1).

#### VDS BZ+ CERTIFIED VERSION

The VDS BZ+ certified version is available on request.

## F9000 Cylinders V3 Half

MODULAR LE60 CYLINDER, MECHATRONIC  
NICKEL-PLATED EUROPEAN MONOPROFILE

### CODE CONFIGURATOR

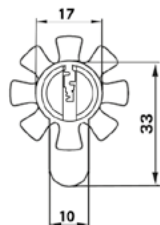
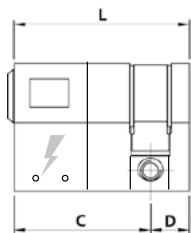
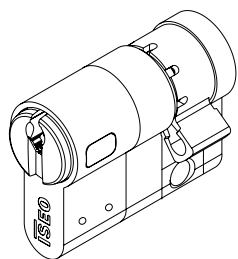

8 M V A 0     1 0 9 M

DIMENSION C	DIMENSION D
30	10
35	
40	
45	
50	
55	
60	
65	
70	
...	
180	

L max 190 mm

EX ATEX version \*  
VD VDS version \*

(\*) delivery time on request

### Product options

#### F9000 ATEX VERSION

The F9000 keys (ON, UP, PR, EM) and F9000 cylinders are available as an option for areas at risk of explosion where explosive or flammable gases may be present. The ATEX version of the keys and cylinders is certified ATEX EX 2 G Ex ib IIB T4 (zone 1).

#### VDS BZ+ CERTIFIED VERSION

The VDS BZ+ certified version is available on request.

## F9000 Cylinders V3 Oval Scandinavian

### MECHATRONIC NICKEL-PLATED SCANDINAVIAN OVAL CYLINDER

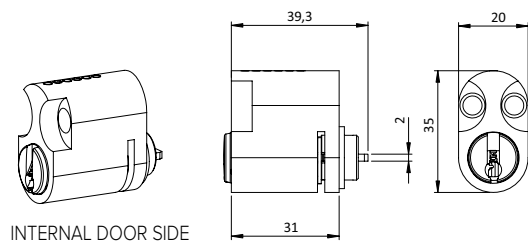
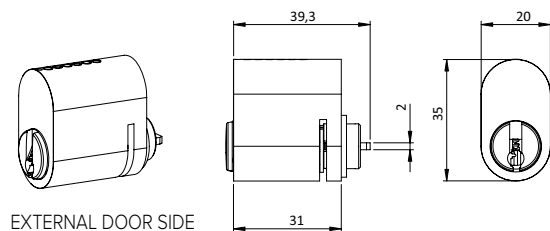

### CODE CONFIGURATOR

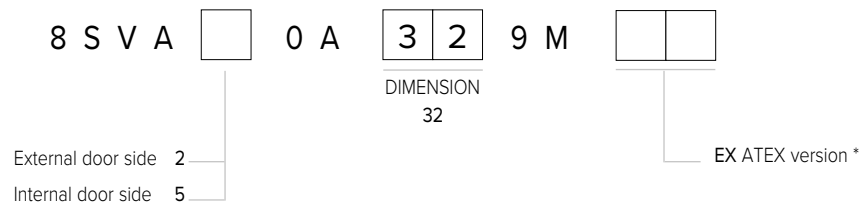

(\*) delivery time on request

### Product options

#### F9000 ATEX VERSION

The F9000 keys (ON, UP, PR, EM) and F9000 cylinders are available as an option for areas at risk of explosion where explosive or flammable gases may be present. The ATEX version of the keys and cylinders is certified ATEX EX 2 G Ex ib IIB T4 (zone 1).



## F9 Cylinders European double profile

MODULAR LE60 CILINDER,  
EUROPEAN NICKEL-PLATED DOUBLE PROFILE

### CODE CONFIGURATOR

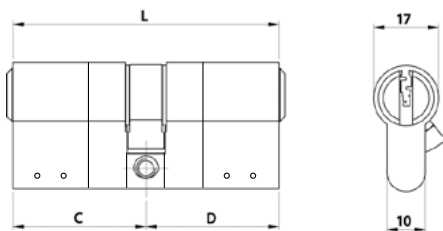
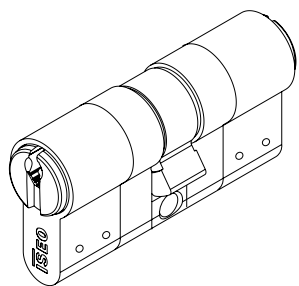

8 M F A			9 M
Standard 0		DIMENSION	DIMENSION
Double Function 9		C	D
		30	30
		35	35
		40	40
		45	45
		50	50
		55	55
		60	60
		65	65
		70	70
		...	...
		180	180
		L max 260 mm*	

- Special length with C=28/33 mm and/or D =28/33 are just in compact version available

### Product options

#### DOUBLE FUNCTION CAM

The rotation of the cam is not linked to the first key inserted. In other words, if a key is inserted on one side, by inserting the second key from the opposite side, we can rotate the cam with both keys inserted.

## F9 Cylinders European double profile, free cam

MODULAR LE60 CILINDER, EUROPEAN  
 NICKEL-PLATED DOUBLE PROFILE, FREE CAM

### CODE CONFIGURATOR

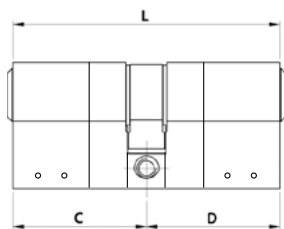
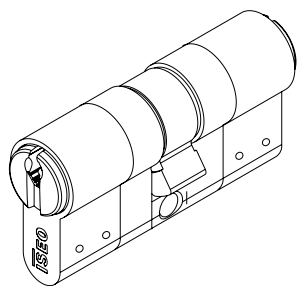

8 M F A L



9 M

DIMENSION

DIMENSION

C

D

30

30

35

35

40

40

45

45

50

50

55

55

60

60

65

65

70

70

...

...

95

95

L max 125 mm\*

## F9 Cylinders European double profile, round knob

MODULAR LE60 CILINDER, EUROPEAN  
 NICKEL-PLATED DOUBLE PROFILE, ROUND KNOB

### CODE CONFIGURATOR

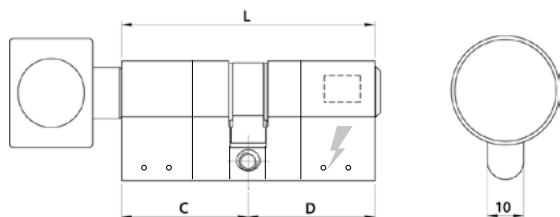
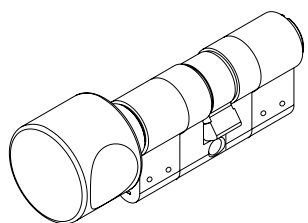

8 M F A 8



DIMENSION  
C



DIMENSION  
D

9 M

30	30
35	35
40	40
45	45
50	50
55	55
60	60
65	65
70	70
...	...
180	180

L max 260 mm\*

- Special lenght with C=28/33 mm and/or D =28/33 are just in compact version available

## F9 Cylinders European single profile

MODULAR LE60 CILINDER, EUROPEAN  
 NICKEL-PLATED SINGLE PROFILE

### CODE CONFIGURATOR

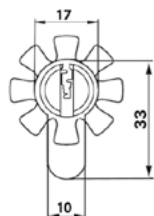
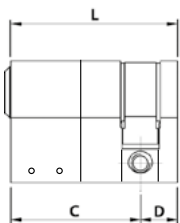
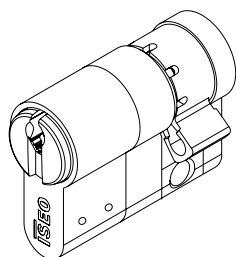

8 M F A 0

--	--

1	0
---	---

9 M

DIMENSION  
C

DIMENSION  
D

30

10

35

40

45

50

55

60

65

70

...

180

L max 190 mm \*

## F9 Cylinders Oval Scandinavian

### OVAL SCANDINAVIAN NICKEL-PLATED CYLINDER

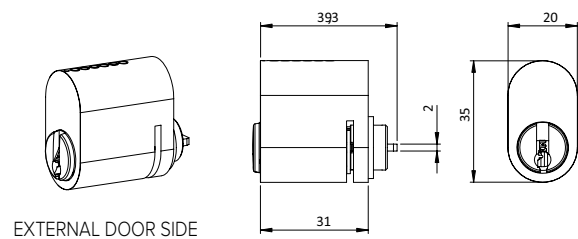

EXTERNAL DOOR SIDE

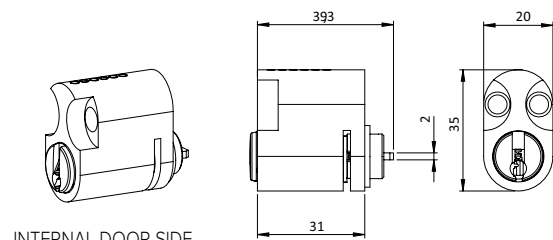

INTERNAL DOOR SIDE

### CODE CONFIGURATOR

8 S F A  0 A 

3	2
---	---

 9 M









DIMENSION  
32

External door side 2  
 Internal door side 5













(\*) delivery time on request

## Phased out products

The table shows the replacement codes for phased out products. If no replacement code is available, please consult the catalogue to assess the right product solution.

Code	Product model	Title	Version	Substitution code		Go to page
8MKx8xxxxx52x	Libra LE60	Standard	2.1	8MKx8xxxxx62x	→	
8MKx0xxxxx52x	Libra LE60	Premium	2.1	8MKx0xxxxx62x	→	
8MKx0xx10xx52	Libra LE60	Half	2.1	8MKx0xx10xx62	→	
8MKxExxxxx52	Libra LE60	Double	2.1	8MKxExxxxx62	→	
8MK36xxxxx52	Libra LE60	Removable reader and Extension plug 16 mm	2.1	8MK36xxxxx62	→	
8MK36D0xxx52	Libra LE60	Removable reader and Extension plug 75 mm	2.1	8MK36D0xxx62	→	
8MKxCxxxx52x	Libra LE60	Dummy-knob	2.1	8MKxCxxxx62x	→	
8SKx90039xx52	Libra LE60	Oval Australian	2.1	8SKx90039xx62	→	
8SKx20032xx52	Libra LE60	Oval Scandinavian	2.1	8SKx20032xx62	→	

## Phased out products

Code	Product model	Title	Version	Substitution code		Go to page
<a href="#">8MSAxxxx9Mxx</a>	F9000 Cylinders LE60 V3	Standard	V3	8MVAxxxx9Mxx	→	
<a href="#">8MSALxxxx9Mxx</a>	F9000 Cylinders LE60 V3	Standard Free Cam	V3	8MVALxxxx9Mxx	→	
<a href="#">8MSExxxx9Mxx</a>	F9000 Cylinders LE60 V3	Double	V3	8MVExxxx9Mxx	→	
<a href="#">8MSELxxxx9Mxx</a>	F9000 Cylinders LE60 V3	Double Free Cam	V3	8MVELxxxx9Mxx	→	
<a href="#">8MSA8xxxx9Mxx</a>	F9000 Cylinders LE60 V3	Knob	V3	8MVA8xxxx9Mxx	→	
<a href="#">8MSA0xx109Mxx</a>	F9000 Cylinders LE60 V3	Half	V3	8MVA0xx109Mxx	→	
<a href="#">8SSAx0A329Mxx</a>	F9000 Cylinders LE60 V3	Oval Scandinavian	V3	8SVAx0A329Mxx	→	
<a href="#">87SA040859M</a>	F9000 Cylinders LE60 V3	External rim nickel-plated, diam. 35 mm, U.S. type	V3	87VA040859M	→	
<a href="#">87SA050859M</a>	F9000 Cylinders LE60 V3	External rim nickel-plated, diam. 40 mm	V3	87VA050859M	→	
<a href="#">87SA23F259M</a>	F9000 Cylinders LE60 V3	Round threaded nickel-plated	V3	87VA23F259M	→	
<a href="#">87SA26M259M</a>	F9000 Cylinders LE60 V3	Threaded nickel-plated M26, with signalling microswitch	V3	87VA26M259M	→	
<a href="#">5E1320126</a>	Stylos	Lettore di credenziali con led		5E152312	→	
<a href="#">5E1322106</a>	Stylos	Lettore di credenziali con led da esterno		5E152312	→	



**ISEO**<sup>®</sup>  
ULTIMATE ACCESS TECHNOLOGIES

**Iseo Serrature s.p.a.**  
Via San Girolamo, 13  
25055 Pisogne BS, Italy  
Tel. +39 0364 8821  
Fax +39 0364 882263  
[iseo@iseo.com](mailto:iseo@iseo.com)

**[iseo.com](http://iseo.com)**